



XPowEr Powerpack 400 Plus and XPowEr Powerpack 400 R

Owner's Guide

About Xantrex

Xantrex Technology Inc. is a world-leading supplier of advanced power electronics and controls with products from 50 watt mobile units to 2.5 MW utility-scale systems for wind, solar, batteries, fuel cells, microturbines, and backup power applications in both grid-connected and stand-alone systems. Xantrex products include inverters, battery chargers, programmable power supplies, and variable speed drives that convert, supply, control, clean, and distribute electrical power.

Trademarks

XPower Powerpack 400 Plus and XPower Powerpack 400 R is a trademark of Xantrex International. Xantrex is a registered trademark of Xantrex International.

Other trademarks, registered trademarks, and product names are the property of their respective owners and are used herein for identification purposes only.

Notice of Copyright

Xpower™ Powerpack 400 Plus and 400 R Owner's Guide © August 2006 Xantrex International. All rights reserved.

Exclusion for Documentation

UNLESS SPECIFICALLY AGREED TO IN WRITING, XANTREX TECHNOLOGY INC.
("XANTREX")

- (a) MAKES NO WARRANTY AS TO THE ACCURACY, SUFFICIENCY OR SUITABILITY OF ANY TECHNICAL OR OTHER INFORMATION PROVIDED IN ITS MANUALS OR OTHER DOCUMENTATION.
- (b) ASSUMES NO RESPONSIBILITY OR LIABILITY FOR LOSSES, DAMAGES, COSTS OR EXPENSES, WHETHER SPECIAL, DIRECT, INDIRECT, CONSEQUENTIAL OR INCIDENTAL, WHICH MIGHT ARISE OUT OF THE USE OF SUCH INFORMATION. THE USE OF ANY SUCH INFORMATION WILL BE ENTIRELY AT THE USER'S RISK; AND
- (c) REMINDS YOU THAT IF THIS MANUAL IS IN ANY LANGUAGE OTHER THAN ENGLISH, ALTHOUGH STEPS HAVE BEEN TAKEN TO MAINTAIN THE ACCURACY OF THE TRANSLATION, THE ACCURACY CANNOT BE GUARANTEED. APPROVED XANTREX CONTENT IS CONTAINED WITH THE ENGLISH LANGUAGE VERSION WHICH IS POSTED AT WWW.XANTREX.COM.

Date and Revision

August 2006 Revision C

Part Number

975-0162-01-01

Product Numbers

XPower Powerpack 400 Plus (FGA) 852-1900

XPower Powerpack 400 R (FGA) 852-1900-01

Contact Information

Telephone: 1 800 670 0707 (toll free North America)
1 360 925 5097 (direct)

Fax: 1 800 994 7828 (toll free North America)
1 360 925 5143 (direct)

Email: customerservice@xantrex.com

Web: www.xantrex.com

About This Guide

Purpose

The purpose of this Owner's is to provide explanations and procedures for installing, operating, maintaining, and troubleshooting the XPower Powerpack 400 Plus and XPower Powerpack 400 R.

The Guide provides safety guidelines, detailed planning and setup information, as well as information about operating and troubleshooting the unit.

Conventions Used

The following conventions are used in this guide.



WARNING

Warnings identify conditions that could result in personal injury or loss of life.



CAUTION

Cautions identify conditions or practices that could result in damage to the product or to other equipment.

Important: These notes describe an important action item or an item that you must pay attention to.

Note: These notes describe additional information which may add to your understanding of how to use the product.

References to XPower Powerpack

In this guide, both the **XPower Powerpack 400 Plus** and the **XPower Powerpack 400 R** (with radio and air compressor) are referred to as **XPower Powerpack** when the information applies to both models. However, when the information is specific to one model, then reference is made specifically to the **XPower Powerpack 400 Plus** or to the **XPower Powerpack 400 R**.

Related Information

You can find more information about Xantrex Technology Inc. as well as its products and services at **www.xantrex.com**.

Important Safety Instructions

The XPower Powerpack 400 Plus and XPower Powerpack 400 R generate a type of AC power similar to a normal household wall outlet. Operating the XPower Powerpack incorrectly or misusing it may damage the equipment or create hazardous conditions for the user.

Important: Before using your XPower Powerpack 400 Plus and XPower Powerpack 400 R, be sure to read and save these safety instructions.

Warnings and Cautions



WARNING: Limitations on Use

The XPower Powerpack 400 Plus and XPower Powerpack 400 R are not intended for use in connection with life support systems or other medical equipment or devices.



WARNING: Shock hazard. Keep away from children.

The XPower Powerpack generates the same potentially lethal AC power as a normal household wall outlet. Do not insert foreign objects into the AC Outlet, the DC Power Socket, the Jump-Start Cable Port, or the ventilation holes. Do not expose this product to water, rain, snow, or spray.

Do not open the XPower Powerpack except to replace the internal battery. Have a qualified technician complete any service work.

Important Safety Instructions

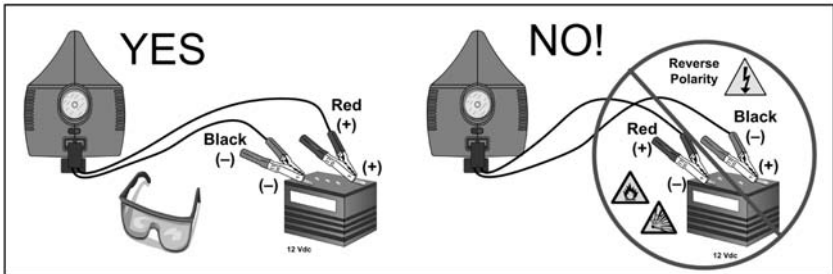
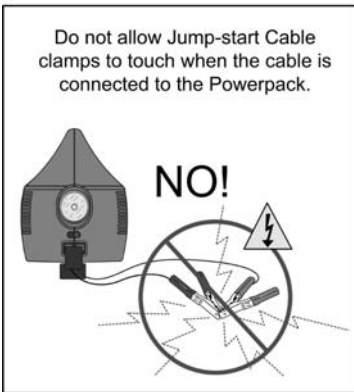
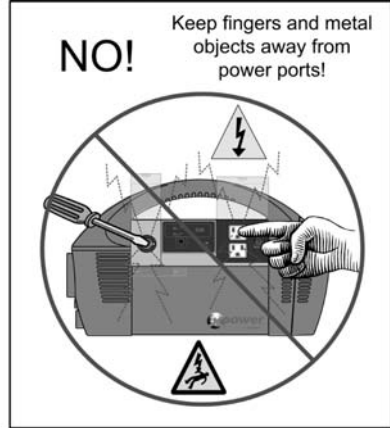
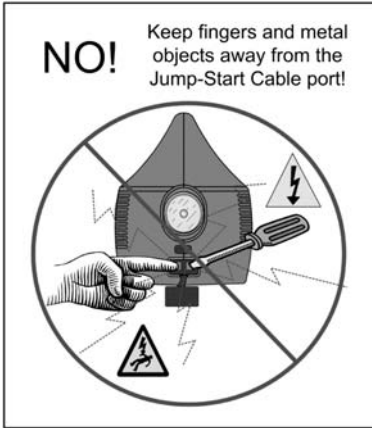

Figure i Basic Safety



WARNING: Explosion hazard

Do not use this product where there are flammable fumes or gases, such as in the bilge of a gasoline- powered boat, or near propane tanks. Do not use this product in an enclosure containing automotive-type lead acid batteries. These batteries, unlike the sealed AGM battery in XPower Powerpack, vent explosive hydrogen gas which can be ignited by sparks from electrical connections.

When working on electrical equipment, always ensure someone is nearby to help you in an emergency.



WARNING: Heated surface

Ensure at least 2" (5 cm) air space is maintained on all sides of the XPower Powerpack. During operation, keep away from materials that may be affected by high temperatures such as blankets, pillows and sleeping bags.



WARNING: Fire hazard

Never allow jump-start cables' red and black clamps to touch each other or another common metal conductor. This could cause damage to the unit and/or create a sparking/explosion hazard. Always disconnect the jump-start cables from the unit after use and clip the plastic guard over the jump-start cable port.



WARNING: Fire hazard

Jump-start cable clamps must be connected positive to positive (red clamp to battery "+") and negative to negative (black clamp to battery "-"). A reverse polarity connection (positive to negative) may cause damage to the unit and/or create a sparking/explosion hazard.



WARNING: Fire hazard

The jump-start feature is designed for short term operation only—less than 4 seconds. Operating the jump-start feature for more than 4 seconds may cause damage to the unit. Allow the XPower Powerpack to cool down for at least 3 minutes after each jump-start.



WARNING: Risk of explosion, fire or burns

The battery terminals exposed at the Jump-Start Cable Port have enough energy present to cause a spark, creating an explosion hazard, or to cause burns if a metal object contacts both terminals. Always clip the plastic guard over the Port when not in use.



WARNING: Fire hazard

Do not leave the compressor unattended while operating. The compressor is designed for short term operation only. Operation of the compressor over an extended period of time will cause the compressor unit to overheat and may cause damage. Allow the compressor to cool down for 10 minutes after each 10 minutes of continuous operation.



CAUTION

Do not connect any AC appliance with the neutral conductor connected to ground to the XPower Powerpack.



CAUTION

Do not expose the XPower Powerpack to temperatures over 104 °F (40 °C).

Precautions When Working With Batteries



WARNING: Explosion and fire hazard

1. Follow all instructions published by the battery manufacturer and the manufacturer of the equipment in which the battery is installed.
 2. Make sure the area around the battery is well-ventilated.
 3. Never smoke or allow a spark or flame in vicinity of the engine or batteries.
-

4. Be careful not to drop a metal object on the battery or allow a metal tool to simultaneously touch the positive and negative cable ends or battery terminals. It might spark or short-circuit the battery or other electrical parts and cause an explosion.
5. Remove personal metal items such as rings, bracelets, necklaces, and watches when working with batteries. Batteries produce a short-circuit current high enough to weld a ring or other similar objects to metal, causing a severe burn.
6. If you need to remove a battery, always remove the positive terminal from the battery first. Make sure all accessories are off so you don't cause an arc.
7. Someone should be within range of your voice, or close enough to come to your aid when you work near batteries.
8. Have plenty of fresh water and soap nearby in case battery acid contacts skin, clothing, and eyes.
9. Wear complete eye protection and clothing protection. Avoid touching your eyes while working near batteries.
10. If battery acid contacts skin or clothing, wash immediately with soap and water. If acid enters your eyes, immediately flood them with running cold water for at least twenty minutes and get medical attention immediately.
11. Keep a supply of baking soda on hand in the area of the batteries. Baking soda neutralizes lead-acid battery electrolyte.

Precautions for Using Rechargeable Appliances



CAUTION

The output of the inverter is non-sinusoidal.

Most rechargeable battery-operated equipment uses a separate charger or transformer that is plugged into an AC receptacle and produces a low voltage charging output.

Some chargers for rechargeable batteries can be damaged if connected to the XPower Powerpack 400 Plus and XPower Powerpack 400 R.

Do not use the following with the XPower Powerpack 400 Plus and XPower Powerpack 400 R:

- Small battery-operated appliances like flashlights, razors, and night lights that can be plugged directly into an AC receptacle to recharge.
- Some chargers for battery packs used in hand power tools. These affected chargers display a warning label stating that dangerous voltages are present at the battery terminals.

Note: If you are unsure about using your rechargeable appliance with the XPower Powerpack, contact the equipment manufacturer to determine the rechargeable appliance's compatibility with the modified sine wave (non-sinusoidal) AC waveform.

Contents

Important Safety Instructions

Warnings and Cautions - - - - -	iii
Precautions When Working With Batteries - - - - -	vi
Precautions for Using Rechargeable Appliances - - - - -	viii

1 Introduction

About the XPower Powerpack - - - - -	1-1
Comprehensive Protection - - - - -	1-1
Automatic Overload - - - - -	1-1
Overheating - - - - -	1-2
Low Battery Protection - - - - -	1-2
Jump-Start Cables Safety Fuse - - - - -	1-2

2 Features

Contents - - - - -	2-1
XPower Powerpack Features - - - - -	2-2
Front Panel - - - - -	2-2
Storage Compartment - - - - -	2-4
Radio (XPower Powerpack 400 R only) - - - - -	2-5
Air Compressor - - - - -	2-6
Emergency Light and Jump-Start Port - - - - -	2-7
Accessories - - - - -	2-8

3 Operation

Operating Conditions and Guidelines	3-1
Choosing a Location	3-2
Recharging the XPower Powerpack Battery	3-3
Charging with the AC Charger	3-4
Charging with the DC-to-DC Accessory Cable	3-6
Recharging with a Generator's Regulated 12 Vdc Outlet	3-8
Recharging From a Solar Panel	3-9
Checking the State-of-Charge	3-10
AC Appliances	3-11
Operating AC Appliances	3-12
Low-Battery Alarm	3-12
Overload Protection	3-13
High Surge Appliances	3-13
Trouble Appliances	3-13
12 Vdc Appliances	3-14
Operating DC Appliances	3-15
Overload Protection	3-15
Low-Battery Alarm	3-15
Control Panel Operation	3-16
Jump-Starting a Vehicle's Engine	3-18
Using the Emergency Light	3-20
Using the Air Compressor	3-22
Over-Temperature Safety Protection	3-24
Inflating Tires	3-25
Inflating Small Sports Equipment	3-27
Using the Radio: XPower Powerpack 400 R	3-28
Power Draw	3-28
Listening to the AM Band	3-28
Radio Features	3-28
Radio Operation	3-29
Connecting to an External Battery	3-30

4 Maintenance

Battery Maintenance - - - - -	4-1
Replacing the Internal Battery - - - - -	4-2
Battery Life - - - - -	4-2
Obtaining a Replacement Battery - - - - -	4-3
Battery Replacement Procedure - - - - -	4-4
Replacing the Incandescent Light - - - - -	4-5
Replacing the External Fuse - - - - -	4-6
Recycling - - - - -	4-7

5 Troubleshooting

Common Problems - - - - -	5-1
Buzz in Audio Equipment - - - - -	5-1
Television Interference - - - - -	5-1
Troubleshooting Reference - - - - -	5-2

A Specifications

Electrical Specifications - - - - -	A-1
Physical Specifications - - - - -	A-4

Warranty and Return - - - - -	WA-1
--------------------------------------	-------------

Figures

Figure 2-1	Package Contents	2-1
Figure 2-2	Front Panel Enlargement	2-2
Figure 2-3	Storage Compartment	2-4
Figure 2-4	Back Panel Radio Enlargement	2-5
Figure 2-5	Air Compressor Features	2-6
Figure 2-6	Emergency Light and Jump-start Port	2-7
Figure 2-7	Accessories and Accessory Bag	2-8
Figure 3-1	Ventilation	3-2
Figure 3-2	Charging with AC Power	3-5
Figure 3-3	Charging with DC Power	3-7
Figure 3-4	Charging with a Solar Panel	3-9
Figure 3-5	Checking the State-of-Charge	3-10
Figure 3-6	Operating AC Appliances	3-12
Figure 3-7	Operating AC Appliances	3-15
Figure 3-8	Using the Control Panel	3-16
Figure 3-9	Using the Jump-start Cables	3-19
Figure 3-10	Emergency Light	3-20
Figure 3-11	Using the Emergency Light	3-21
Figure 3-12	XPower Powerpack Air Compressor	3-23
Figure 3-13	Value Connector Usage	3-23
Figure 3-14	Nozzle Adapter Usage	3-24
Figure 3-15	Inflating tires	3-26
Figure 3-16	Inflating Small Sports Equipment	3-27
Figure 3-17	Radio Features	3-28
Figure 3-18	Basic Jump-start Cable Safety	3-31
Figure 3-19	Connecting the XPower Powerpack to an External Battery	3-32
Figure 4-1	Accessing the Internal Battery for Replacement	4-4
Figure 4-2	Replacing the Fuse	4-6

1

Introduction

About the XPower Powerpack

Easy-to-use and designed for years of reliable service, the XPower Powerpack can run many AC appliances and 12 volt DC appliances whenever you need power for work or play, at home or on the road.

XPower Powerpack:

- Powers 115 volt AC appliances
- Powers 12 volt DC appliances
- Jump-starts vehicle engines
- Provides lighting for emergency use
- Inflates tires and small sports equipment with a 250 psi air compressor.

In addition, the XPower Powerpack 400 R comes with:

- An AM/FM radio with digital alarm clock.

Comprehensive Protection

Automatic Overload

The XPower Powerpack has built-in protection against output overload. If you connect an appliance that draws more than 320 W to the AC Outlet(s), or one which draws excessive surge power, the power to the AC Outlet automatically shuts off. The unit will reset automatically after the loads are removed and the unit cools down.

The DC Socket is protected by a thermal switch that monitors the temperature of the socket. If an overload condition occurs while using the DC Socket, the excessive temperature will shut down the power to the Socket.

Overheating

The XPower Powerpack is protected from overheating. If the inverter exceeds a safe temperature, power to the AC Outlet and DC Socket automatically shuts off. It will reset automatically after the unit cools down.

Low Battery Protection

Low battery protection protects the internal battery from excessive discharge and possible damage. When the AC Outlet ON/OFF switch is turned on, an audible alarm alerts you when the internal battery is nearly discharged (11.0Vdc) and the unit turns off at 10.5 Vdc.



CAUTION

When using only the DC Socket to power your loads, be sure to turn the AC Outlet ON/OFF switch to ON. This ensures that the Low Battery Alarm will sound and will alert you to a low battery condition. Failure to turn the AC Outlet ON/OFF Switch to ON when using the DC Socket can allow the unit to be over-discharged which can destroy the battery. Over-discharging the battery in this manner will void the unit's warranty.

Jump-Start Cables Safety Fuse

The XPower Powerpack comes with a user-replaceable 250 A fuse to protect the unit and vehicle battery from damage through reverse polarity and short-circuit conditions.

2 Features

Chapter 2 describes the main features of the XPower Powerpack. We recommend that you familiarize yourself with these features before operating the unit.

Contents

Your XPower Powerpack package includes the items shown in Figure 2-1.

If any of these materials are missing or are unsatisfactory in any way, please contact Customer Service, see Appendix WA.

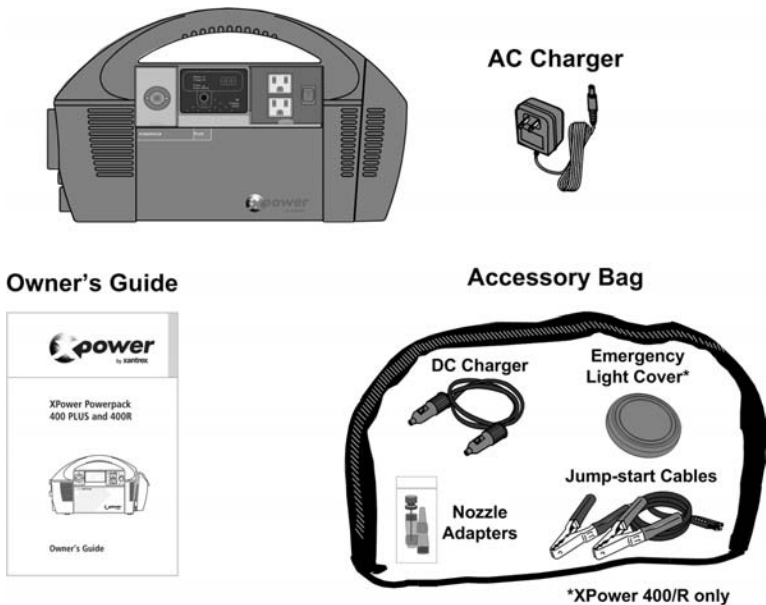

Figure 2-1 Package Contents

XPower Powerpack Features

Front Panel

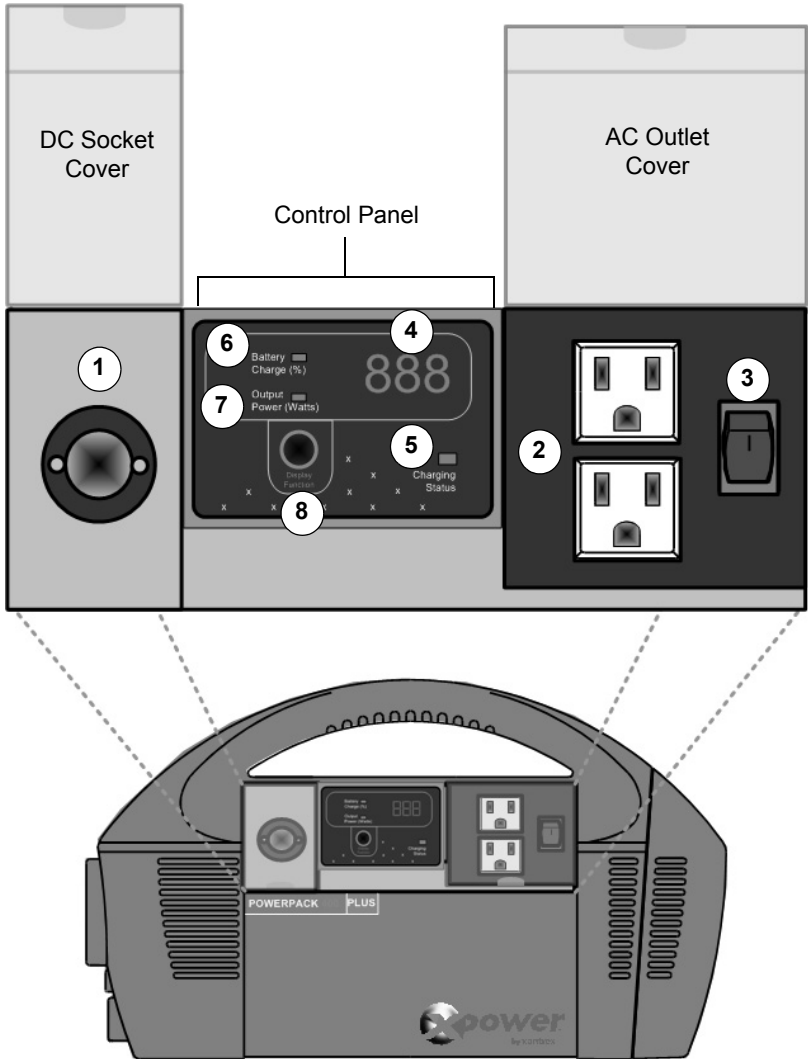
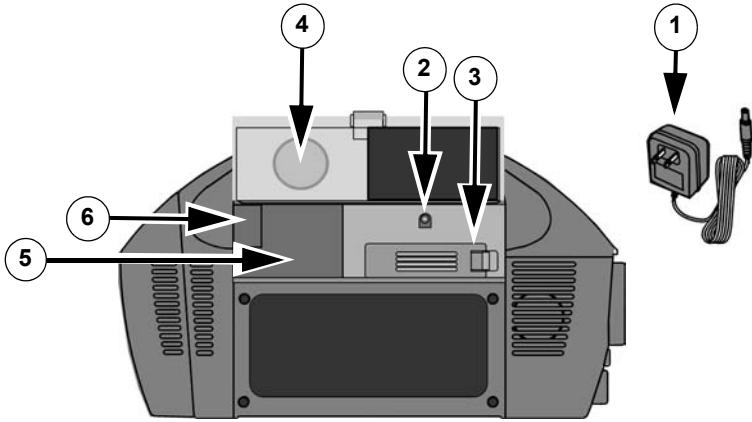

Figure 2-2 Front Panel Enlargement

Feature	Description
①	<p>DC Power Socket can:</p> <ul style="list-style-type: none"> • Power 12 volt DC auto, RV, or marine appliances. • Recharge XPower Powerpack from a 12 V outlet in a vehicle using the DC Charging Cable.
②	<p>Two AC Outlets are standard 3-prong outlets supplying 120 Vac power for running AC appliances.</p>
③	<p>AC Outlet ON/OFF switch turns power on and off to the AC Outlets. The switch illuminates when the switch is turned on and power becomes available at the AC outlets.</p>
④	<p>Digital Display displays the inverter's Output Power in W or Battery Charge status in % FULL.</p>
⑤	<p>The Charging Status light illuminates and blinks when the XPower Powerpack starts charging using the AC Charger. The light will illuminate solid when the battery has reached it's full charge. This light only works when the unit is being charged using the 3.5mm Charger Input Socket in the storage compartment of the unit. This light does not illuminate when charging through the DC Socket.</p>
⑥	<p>Battery Charge % light illuminates (green) when Battery Charge information is displayed on the Digital Display.</p>
⑦	<p>Output Power (W) light illuminates (green) when Output Power information is displayed on the Digital Display.</p>
⑧	<p>Display Function button provides the means for alternating between showing the Output Power or the Battery Charge on the Digital Display. This button also turns the power to the display ON or OFF to conserve power.</p>
Not shown	<p>Audible Alarm (inside the unit) sounds in the event of an over-temperature condition or a low battery condition. This feature only works when the AC Outlet On/Off Switch is in the ON position.</p>

See “Control Panel Operation” on page 3–16 for detailed instructions on using the Control Panel.

Storage Compartment



XPower Powerpack 400 R shown.

Figure 2-3 Storage Compartment

Feature	Description
①	AC Charger lets you recharge the XPower Powerpack from a standard AC wall outlet and can only be used to recharge the internal battery of the XPower Powerpack. The charger can be stored in AC charger compartment or in the Accessory Bag.
②	Charger Input Socket for use with the AC Charger supplied.
③	External, Replaceable Fuse is rated at 250 A, 32 V. Located behind fuse cover.
④	Red “emergency” light cover lens holder. XPower Powerpack 400 R models only.
⑤	AC Charger compartment may be used for storing the AC Charger.
⑥	Compressor Nozzle Adaptor compartment Can be used instead of the Accessory Bag for storing the adaptor nozzles.

Radio (XPower Powerpack 400 R only)

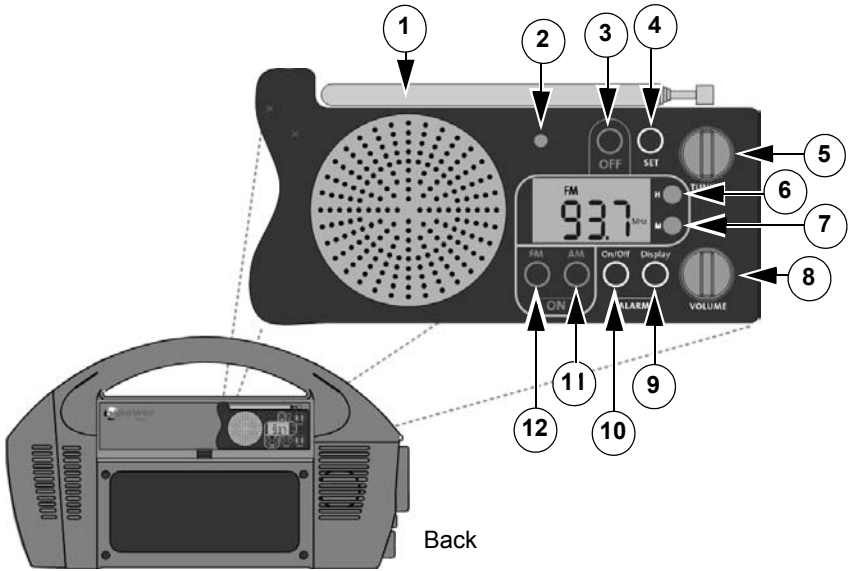

See “Using the Radio: XPower Powerpack 400 R” on page 3–28.

Figure 2-4 Back Panel Radio Enlargement

Feature	Description	Feature	Description
①	FM antenna	⑦	Minutes set button
②	Frequency indicator light	⑧	Volume dial
③	Power OFF button	⑨	Alarm set button
④	Time set button	⑩	Alarm clock ON/OFF button
⑤	Tuning dial	⑪	AM band button/ON
⑥	Hours set button	⑫	FM band button/ON

See “Radio Operation” on page 3–29 for detailed instructions for using the radio features.

Air Compressor

IMPORTANT:
250 psi Maximum.

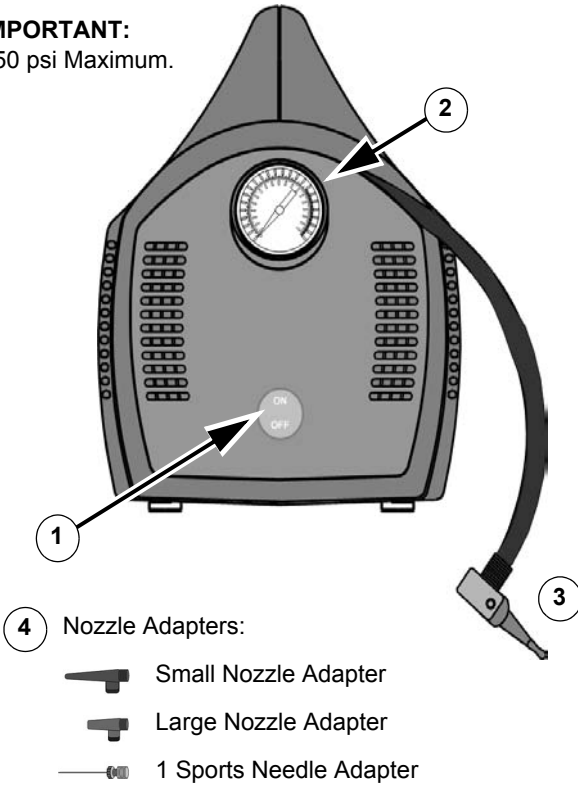

Figure 2-5 Air Compressor Features

Feature	Description
①	ON/OFF switch turns the compressor unit on and off.
②	Pressure gauge shows the PSI (lbs/in ²)
③	Valve connector with connector hose
④	Nozzle Adapters (one Large and Small Nozzle adapter, 1 sports needle adapter)

Emergency Light and Jump-Start Port

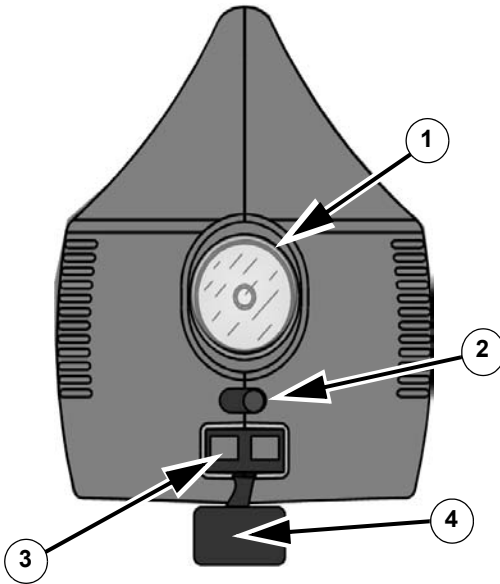

Figure 2-6 Emergency Light and Jump-start Port

Feature	Description
1	5 W incandescent light illuminates for about 30 hours when the battery is fully charged.
2	Light ON/OFF Switch (400 Plus) Light ON/OFF/Pulse Switch (400R)
3	Jump-Start Cable Port supplies high power DC current. The cables connect to the Jump-Start Cable Port when jump-starting a vehicle's battery or when connecting an external battery to the XPower Powerpack. The jump-start cable connection is designed so that the cables cannot be inserted incorrectly into the Jump-Start Cable Port.
4	Plastic Guard for covering Jump-Start Cable Port.

Accessories

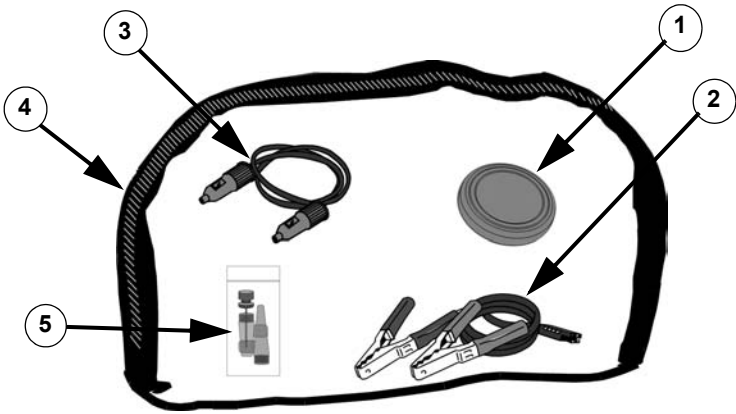

Figure 2-7 Accessories and Accessory Bag

Feature	Description
①	Red emergency light cover lens stored in the rear compartment (XPower Powerpack 400 R only). This cover can turn the 5 W incandescent light into a red “emergency” light when placed over the existing clear lens.
②	Detachable heavy-duty jump-start cables provide the means to jump-start a vehicle that uses a 12 Vdc battery. This cable can also attach to an external battery to extend unit run-time.
③	DC Charging cable lets you recharge the XPower Powerpack from a 12 volt system in a car, SUV, RV, or a boat. This can be stored in the storage compartment or in the Accessory Bag.
④	Accessory bag - transparent, zippered bag for storing accessories that won’t fit in the Storage Compartment.
⑤	Nozzle packet contains two nozzle adaptors (one large and one small) and one sports needle adaptor. These can be stored in the smaller compartment within the AC Charger Compartment.

3

Operation

Chapter 3 explains how to operate the XPower Powerpack efficiently. This chapter covers:

- Choosing a Location (page 3–2)
- Recharging the XPower Powerpack (page 3–3)
- Operating AC appliances (page 3–11)
- Operating 12 volt DC appliances (page 3–14)
- Control Panel Operation (page 3–16)
- Jump-starting a vehicle’s engine (page 3–18)
- Using the Emergency light (page 3–20)
- Using the Air compressor (page 3–22)
- Radio Operation (page 3–28)
- Connecting to an external battery for additional run time (page 3–30)

Operating Conditions and Guidelines



CAUTION

Read all operating instructions before operating the XPower Powerpack.



CAUTION

The XPower Powerpack is not intended for use as a UPS (Uninterruptible Power Supply).



WARNING: Limitations on Use

The XPower Powerpack 400 Plus and XPower Powerpack 400 R are not intended for use in connection with life support systems or other medical equipment or devices.

Choosing a Location



WARNING: Fire or explosion

The XPower Powerpack contains components that tend to produce arcs or sparks. To prevent fire or explosion, do not operate the XPower Powerpack in compartments containing batteries or flammable materials, or in locations that require ignition-protected equipment.

The XPower Powerpack should be operated only in locations that meet the following requirements.

- Dry** Do not allow water or other liquids to drop or splash on the XPower Powerpack.
- Cool** Ambient air temperature should be between 32 and 104°F (0 and 40°C) — the cooler the better within this range.
- Ventilated** Leave at least 2" (5 cm) clearance around the XPower Powerpack for air flow. Ensure that the ventilation openings are not obstructed.
- Safe** Do not operate the unit in the same compartment as batteries or in any compartment capable of storing flammable liquids like gasoline.
- Protected from battery gases** Do not operate the unit where it will be exposed to battery gases. These gases are very corrosive and prolonged exposure will damage the XPower Powerpack.

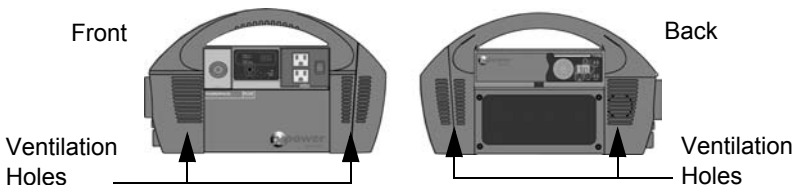

Figure 3-1 Ventilation

Attention: Charge Before Use

Charge the XPower Powerpack for at least 48 hours immediately after purchase. Recharge after each use and once every three months. See “Recharging the XPower Powerpack Battery”.

Failure to follow these instructions will void the product warranty.

Recharging the XPower Powerpack Battery

You can recharge the battery using one of the following methods:

- the AC Charger (provided) plugged into a standard 120 Vac wall outlet,
- the DC Charging Cable (provided) to recharge from your vehicle as you drive,
- a generator equipped with a regulated 12-volt battery charging outlet, or
- a 12-volt DC, 2.5A (or 30 W) solar panel (additional hardware is required for this method). See page 3–9 for details.



CAUTION

Do not attempt to charge the XPower Powerpack battery if it is frozen. Gradually warm the frozen battery to 32 °F (0 °C) before charging.



CAUTION

Do not operate AC or DC appliances while the XPower Powerpack is being charged.

Note: The **Battery Charge (%)** reading on the digital display is only accurate when the XPower Powerpack has been disconnected from all appliances and all charging sources for fifteen minutes.

Charging with the AC Charger

Using the AC Charger is the simplest method for recharging the battery. While charging from an AC source, the Charging Status LED on the Control Panel will flash. The LED will illuminate steady when the battery has reached capacity.

Charging using this method can take approximately 35 hours assuming the battery is fully-discharged and that there is a full 120 volts of power at the AC wall outlet being used. If the voltage at the wall outlet is less than 120 Vac, it may take more than 35 hours to fully recharge the XPower Powerpack. If, after 35 hours of charging, the green Charging Status LED is still flashing, continue to charge the unit for another 15 hours.

The AC Charger for the XPower Powerpack uses standard 120 Vac power outlets. The AC Charger Input Socket is located in the Storage Compartment on the back of the unit. The Input Socket connects to a regulated relay that monitors the input for charging to prevent the battery from being overcharged. Once the battery reaches 100% charge level, the relay opens to disconnect the charging source from the unit and the unit goes into a maintenance charge mode. This feature allows the XPower Powerpack to remain connected to the AC Charging source until it's needed to power loads.

It is recommended that the XPower Powerpack be stored with the AC Charger connected to a 120 Vac power outlet if possible. This keeps the battery fully charged and ready for use. This storage method also prevents the battery from being over-discharged by non-use over a long period of time. If you must store the XPower Powerpack with no AC power available, remember to pull it out and recharge it approximately every three months. ***Failure to do so may irreparably damage the battery and renders the unit inoperable. Damage occurring in this manner is not covered by the product warranty.***

Note: You may hear a clicking noise when the relay opens up to start charging. This is normal. It should stop as the charging voltage rises. If the clicking noise does not stop, disconnect the AC Charger and contact Customer Service for assistance.

Recharging the XPower Powerpack Battery



1. Ensure the Emergency Light Switch is in the **OFF** position. (Center)

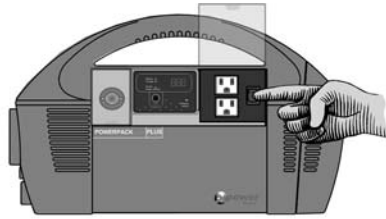

2. Ensure the AC Power Switch is in the **OFF** Position.

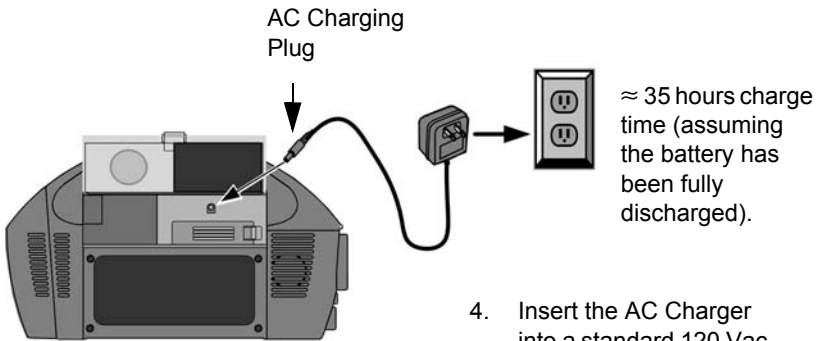

3. Insert the AC Charging plug into the Charger Input Socket inside the Storage Compartment on the back of the unit.

4. Insert the AC Charger into a standard 120 Vac outlet.

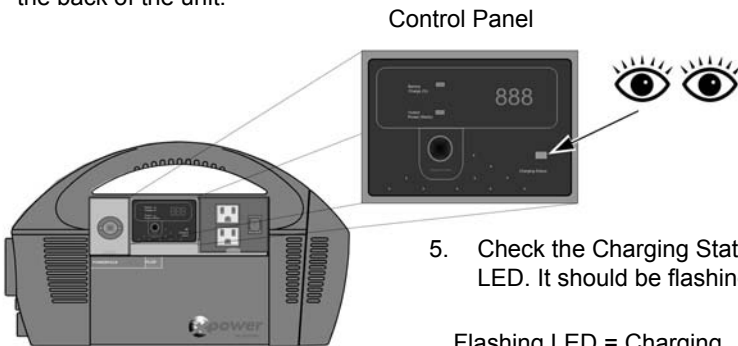

5. Check the Charging Status LED. It should be flashing.

Flashing LED = Charging
Steady ON LED = Standby

Figure 3-2 Charging with AC Power

Charging with the DC-to-DC Accessory Cable



WARNING: Fire and explosion hazard

Do not use this recharging method if your vehicle has abnormally high voltage electrical systems that operate above 15 Vdc. This may lead to accumulations of hydrogen, causing exposure to fire and explosion hazard. This is typically found in marine applications or on portable generators with DC output.

Important: Although the charge regulation circuitry for the AC charging method does not operate with the DC-to-DC charging method, most vehicle voltage regulators will ensure that the XPower Powerpack is not overcharged.

The XPower Powerpack comes with a DC Charging cable to allow the unit to be charged from a DC source such as an automobile, RV, or boat. The DC Charging Input Port is the DC Socket on the front of the unit. The vehicle to be used for charging must have a 12 Vdc accessory socket and must be running in order to charge the unit.

Important: Disconnect the unit as soon as the battery is fully charged or if the vehicle's engine is turned off. Do not leave the XPower Powerpack permanently connected to the vehicle's 12 V accessory outlet.

Note: The green **Charging Status** light will not illuminate when the XPower Powerpack is recharged through the DC Charging Cable.

Note: **Battery Charge (%)** indicator is only accurate when the XPower Powerpack has been disconnected from all appliances and all charging sources for fifteen minutes.

1. Insert one end of the DC Charging Cable into the DC Socket on the front unit.

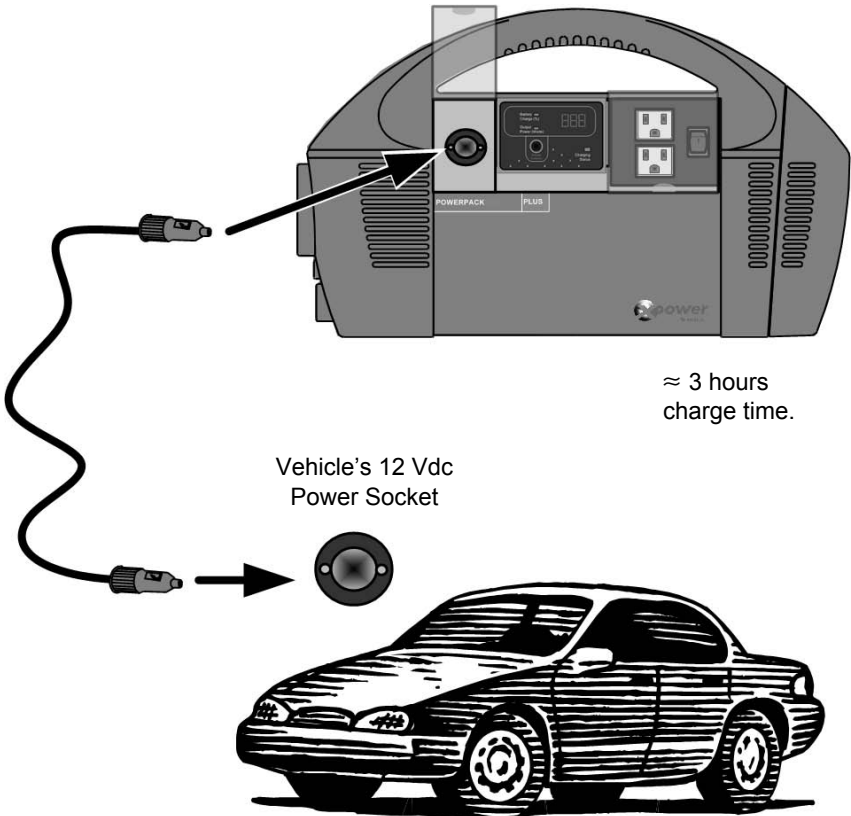

2. Ensure the vehicle's engine is running and insert the other end of the DC Charging Cable into the 12 Vdc Accessory Socket in the vehicle.
3. Disconnect the unit as soon as the battery is fully charged or if the vehicle's engine is turned off.

Figure 3-3 Charging with DC Power

Recharging with a Generator's Regulated 12 Vdc Outlet



WARNING: Fire and explosion hazard

The generator output must be intended for battery charging and have an output of 15 volts or less. An unregulated output or one that exceeds 15 Vdc can damage the battery.

This may lead to accumulations of hydrogen, causing exposure to fire and explosion hazard.

Refer to the Owner's Guide accompanying your generator for detailed instructions on connecting the generator to a unit like the XPower Powerpack.

You can recharge the battery of the XPower Powerpack using a generator in several ways:

- Using the AC Charger to recharge the XPower Powerpack from a generator is possible, but would require extended generator running time.
- Using a generator which has an auxiliary regulated DC output designed for charging 12-volt batteries. Most generators are equipped with them. Use this power source for faster charging.
- Using a generator with a regulated 12 Vdc accessory socket. Follow the connection instructions in "Charging with the DC-to-DC Accessory Cable" on page 3–6.

Most of the XPower Powerpack's battery capacity will be recharged in a few hours.

Note: **Battery Charge (%)** indicator is only accurate when the XPower Powerpack has been disconnected from all appliances and all charging sources for fifteen minutes.

Recharging From a Solar Panel

Small, unregulated 12-volt solar panels can be used to charge the XPower Powerpack through the AC Charger Input Socket on the back of the unit. The solar panels must be rated to produce a maximum of 2.5 amps (or 30 watts) maximum.

Some panels may already come with the appropriate hardware. If not, you will need to purchase a **standard 2.5 mm x 5.5 mm (0.10" x 0.217") ID DC Coaxial Connector (barrel type)** to mate with the AC Charger Input Socket.

To connect the solar panel to the DC Coaxial Connector:

1. Connect the solar panel's red positive (+) wire to the coaxial plug's inner contact.
2. Connect the solar panel's black negative (-) wire to the plug's outer contact.

To recharge with a solar panel:

1. Connect the solar panel to the AC Input Socket on the back of the unit.
2. Place the solar panel in direct sunlight.

It takes about 10 hours in direct sunlight to recharge the XPower Powerpack from a 2.5-amp solar panel.

Additional Hardware Required*:

(*Might come with PV array. Does not come with XPower Powerpack.)

**Standard 2.5 mm x 5.5 mm
(0.10" x 0.217")
ID DC Coaxial Connector
(barrel type)**

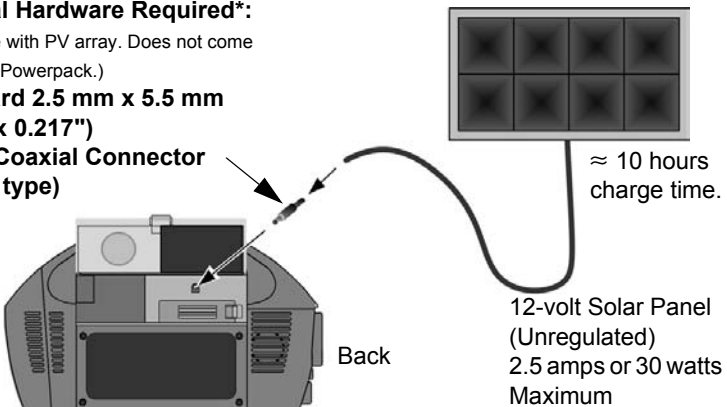
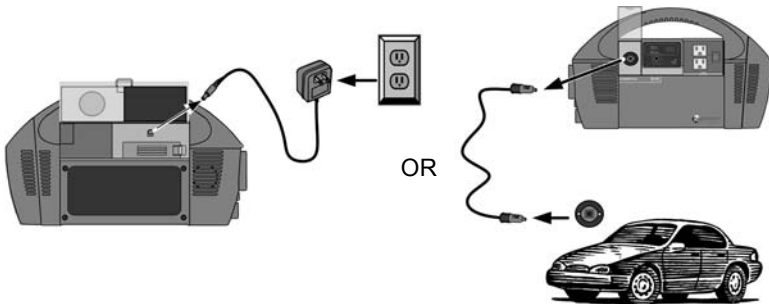

Figure 3-4 Charging with a Solar Panel

Important: If using the DC-to-DC accessory cable socket to charge the unit using solar panels, the solar panel must be regulated. Solar panels can rest at up to 18 Vdc with full sunlight when batteries are full. This can cause damage to the battery. This kind of damage is not covered under the warranty.

Checking the State-of-Charge

Note: Battery Charge (%) indicator is only accurate when the XPower Powerpack has been disconnected from all appliances and all charging sources for fifteen minutes.



1. Disconnect the XPower Powerpack from it's charging source.
2. Wait 15 minutes.

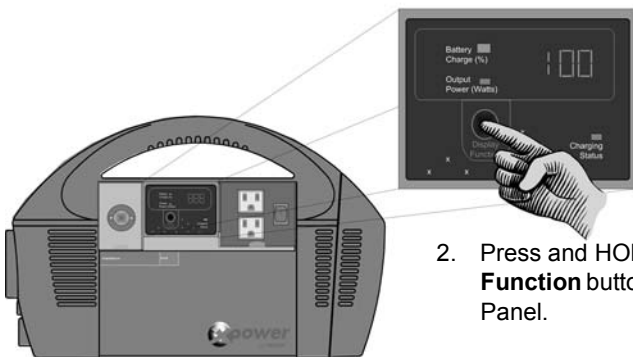

2. Press and HOLD the **Display Function** button on the Control Panel.

100 = Full Charge

Figure 3-5 Checking the State-of-Charge

AC Appliances

The XPower Powerpack has two AC power outlets for use with AC appliances. You can either plug the appliance directly into the AC outlet on the XPower Powerpack or you can use an AC power bar to increase the number of outlets available. However, the combined loads cannot exceed 320 watts AC (2.66 amps). The fewer the watts an appliance uses, the longer the XPower Powerpack will operate before recharging is required.

Some appliances may be difficult or impossible to operate from the XPower Powerpack. They may have high surge requirements or should not be run from the XPower Powerpack. See “High Surge Appliances” on page 3–13 and “Trouble Appliances” on page 3–13.

Important: *Know the size of the loads.*

$$320 \text{ watts AC Maximum Load}$$

$$\text{Amps} \times \text{Volts} = \text{Watts}$$

$$2.66 \text{ amps AC} \times 120 \text{ volts AC} = 320 \text{ watts AC}$$

Typical AC appliances that can be used on the XPower Powerpack are listed in Table 3-1.

Table 3-1 Typical AC Appliances and Run Times

AC Appliance	Watts ^a	Hours ^b
Cordless telephone (stand by)	5	40 hours
Home security system	5	40 hours
Fluorescent work light	14	10 hours
Fireplace fan	20	8 hours
Laptop computer	25	6 hours
Table lamp	40	3 hours
Color TV – 13"	60	2 h 30 m
3/8" drill	190	20 minutes

- a. Represents actual power consumption as measured on sample appliances.
 b. Operating times assume a fully charged 20 Ah battery and may vary based on model/brand of appliance.

Operating AC Appliances

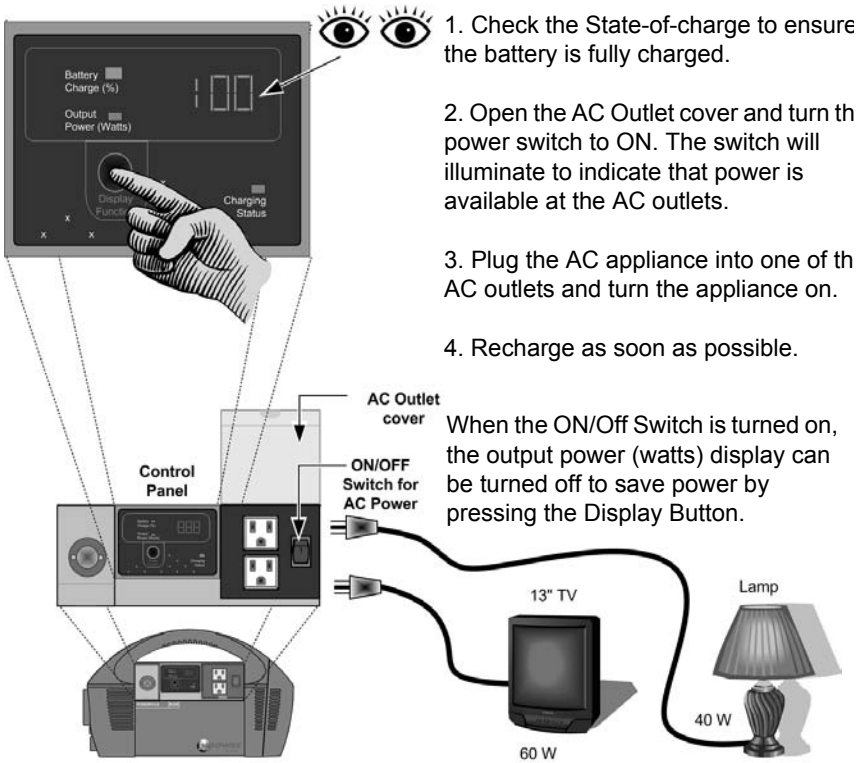

Figure 3-6 Operating AC Appliances

Low-Battery Alarm

While in use, when the battery reaches 11 Vdc, the Low-Battery Alarm will sound indicating that battery is low the unit is about to be shutdown to prevent battery damage.

When the battery reaches 10.5 Vdc, the unit will automatically disconnect power to the AC outlets.

If the alarm sounds, disconnect any loads that may be in use and recharge the unit as soon as possible.

Overload Protection

In the event of an overload (> 320 Wac) or overheating, the XPower Powerpack automatically shuts down. Remove the load. The unit should reset.

High Surge Appliances

The wattage rating of AC appliances is the average power used by the appliance. Appliances such as televisions, computer monitors and appliances with motors consume much more power than their average rating when they are first switched on.

Although XPower Powerpack can supply momentary surge power up to 600 W, some appliances may exceed the capabilities of the XPower Powerpack and trigger the inverter's safety overload shutdown circuit.

Trouble Appliances



CAUTION

The output of the XPower Powerpack inverter is non-sinusoidal. Some equipment may be damaged by the inverter's modified sine wave output (non-sinusoidal).

Some appliances, including the types listed below, may be damaged if they are connected to the inverter:

- Electronics that modulate RF (radio frequency) signals on the AC line will not work and may be damaged.
- Speed controllers found in some fans, power tools, kitchen appliances, and other loads may be damaged.
- Some chargers for small rechargeable batteries can be damaged. See "Precautions for Using Rechargeable Appliances" on page viii for details.
- Metal halide arc (MHI) lights can be damaged.

Note: If you are unsure about powering any device with the inverter, contact the manufacturer of the device.

12 Vdc Appliances

The XPower Powerpack can operate one 12 Vdc auto, RV, marine, or other portable appliance that draws 12 amps or less from a 12 Vdc power outlet or from a vehicle's accessory socket. The fewer watts a 12 Vdc appliance draws, the longer the XPower Powerpack will operate before recharging is required.

Important: *Know the size of the loads.*

$$144 \text{ watts DC Maximum Load}$$

$$\text{Amps} \times \text{Volts} = \text{Watts}$$

$$12 \text{ amps DC} \times 12 \text{ volts DC} = 144 \text{ watts DC}$$



CAUTION Equipment damage

The DC Power Socket does not automatically switch off when the internal battery is discharged.

To protect the internal battery against damage resulting from total discharge, turn the AC Outlet ON/OFF switch to **ON** when using the XPower Powerpack to operate a 12 Vdc appliance.

Having the AC Outlet ON/OFF switch turned **ON** enables the low-battery alarm to warn you when the 12 Vdc appliance has nearly depleted the internal battery. This should allow you adequate time to remove the load and prevent damage to the battery.

Typical 12 Vdc appliances that can be used on the XPower Powerpack are listed in Table 3-2.

Table 3-2 Typical 12 Vdc Appliances and Run Times

12 Vdc Appliance	Watts ^a	Hours ^b
5 W incandescent light (built into the unit)	5	30
Cellular telephone ^c	6	30
Small Portable Cooler	30	4

- a. Represents actual power consumption as measured on sample appliances.
- b. Operating times assume a fully charged 20 Ah battery and may vary based on model or brand of appliance.
- c. Represents talks time available from 10 recharge cycles.

Operating DC Appliances

1. Check the State-of-charge to ensure the battery is fully charged.
2. To enable the low-battery alarm, open the AC Outlet cover and turn the power switch to ON.
3. Plug the DC appliance into the DC socket and turn the appliance on (if required).
4. Recharge as soon as possible.

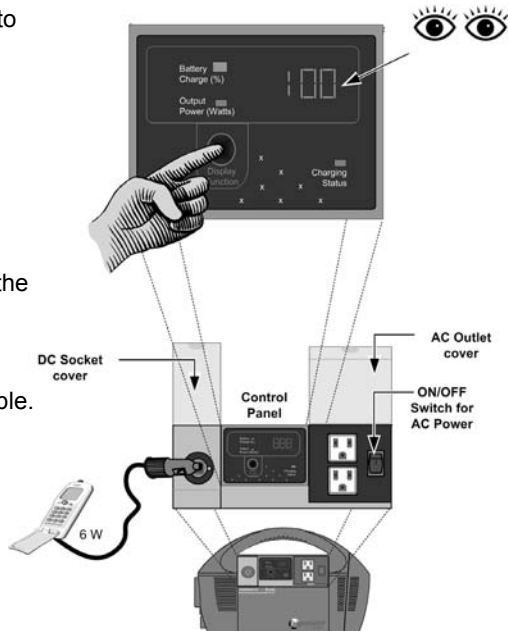

Figure 3-7 Operating AC Appliances

Overload Protection

If the 12 Vdc appliance draws more than 12 amps (or has a short-circuit defect), the internal circuit breaker of the XPower Powerpack shuts off the power to the 12 Vdc appliance. If this occurs, unplug the 12 Vdc appliance, and the internal circuit breaker automatically resets after a few seconds.

Low-Battery Alarm

The DC power socket is internally wired directly to the internal battery and does not have its own alarm. Extended operation of a 12 Vdc appliance could result in excessive battery discharge. To prevent this, turn on the AC Power Switch when running DC loads. This will activate the alarm used for AC loads. Reread the CAUTION for “Equipment damage” on page 3–14.

Control Panel Operation

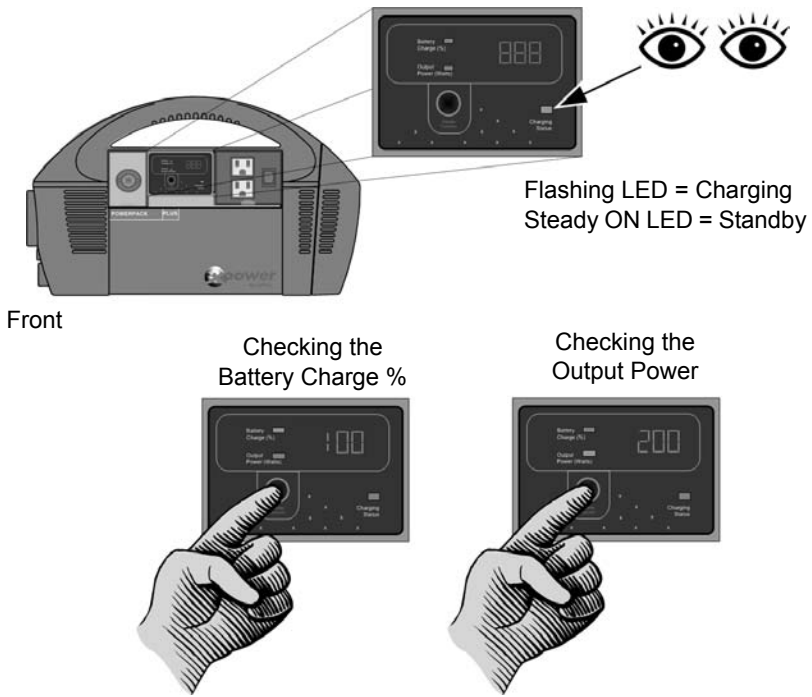

Figure 3-8 Using the Control Panel

How to...	Required Condition	Required Action	Note
Monitor total AC power consumed by the applications powered from the Powerpack's two AC outlets	Inverter's ON/OFF switch is turned ON; Output Power (W) light illuminates (green); AC charger is unplugged from the wall AC outlet.	No action required. The Digital Display will show the AC power drawn from the inverter by the applications powered from the Powerpack's AC outlets.	In order to save the battery power and ensure longer inverter run time, press Display Function button to turn off the Digital Display. Press Display Function button again to turn the display on for AC power reading.

How to...	Required Condition	Required Action	Note
Monitor Battery Charging status	<p>Inverter's ON/OFF switch is turned to OFF;</p> <p>All appliances must be disconnected from the AC and DC power outlets;</p> <p>The ON/OFF switch of the incandescent light must be turned to OFF;</p> <p>The AC charger must be plugged into the Powerpack's Charger Input Socket and also in to a household AC outlet.</p>	<p>No action required.</p> <p>A flashing green Charging Status light indicates that the Powerpack's battery needs recharging and that the AC charger is charging the battery.</p> <p>A steady green Charging Status light indicates that the Powerpack's battery is fully charged and the Powerpack is ready for use.</p>	<p>Recharging with the supplied AC charger is a true "plug-in-and-forget" charging method.</p> <p>We recommend leaving the AC charger connected when the Powerpack is not in use to permanently maintain the battery in fully charged condition.</p>
Check Battery Charge status	<p>Inverter's ON/OFF switch is turned to OFF;</p> <p>All appliances must be disconnected from the AC and DC power outlets;</p> <p>The ON/OFF switch of the incandescent light must be turned to OFF;</p> <p>The AC charger must not be plugged into the Powerpack's Charger Input Socket.</p>	<p>Push and hold the Display Function button.</p> <p>The green Battery Charge (%) light will come on and the Digital Display will show the remaining battery capacity in %.</p>	<p>This function is disabled when the AC charger is plugged in to the Charger Input Socket, or when the inverter main switch is ON.</p> <p>For accurate Battery Charge reading, allow 15 minutes between charging/use and battery capacity check.</p>

Jump-Starting a Vehicle's Engine

You can use the XPower Powerpack to jump-start a vehicle or boat engine that has a 12-volt starting battery using the Jump-Start cables supplied with the unit.



WARNING: Fire hazard

Never allow cables' red and black clamps to touch each other or another common metal conductor. This could cause damage to the unit and/or create a sparking/explosion hazard. Always disconnect the clamps for the unit after use and clip the plastic guard over the jump-start cable port.



WARNING: Fire hazard

Jump-start cable clamps' connection to the vehicle's battery terminals must be positive to positive (red clamp to battery "+") and negative to negative (black clamp to battery "-"). A reverse polarity connection (positive to negative) may cause damage to the unit and/or create a sparking/explosion hazard.



WARNING: Risk of explosion, fire or burns

The battery terminals exposed at the Jump-Start Cable Port have enough energy present to cause a spark, creating an explosion hazard, or to cause burns if a metal object contacts both terminals. Always clip the plastic guard over the Port when not in use.



WARNING: Fire hazard

The jump-start feature is designed for short term operation only—less than 4 seconds. Operating the jump-start feature for more than 4 seconds may cause damage to the unit. Allow the XPower Powerpack to cool down for at least 3 minutes after each jump-start.

Important: Closely follow these instructions for jump-starting your vehicle as they may be different from the instructions supplied with other jump-start products or jump-start cables.

To jump-start a vehicle or boat engine:



<p>1 Ensure Correct Polarity:</p> <p>Ensure Emergency Brake is engaged and transmission is in Neutral.</p> <p>YES!</p>  <p>NO!</p> 	<p>2 To connect Jump-Start Cables:</p>  <p><i>*The black negative (-) clamp of the cables can be connected to the engine block, cylinder head, or other stationary heavy metal part of the motor or to the negative (-) battery terminal.</i></p> <p>Ensure all cables are clear of belts and fans.</p> <p>NO!</p>  <p>Do not allow Jump-start Cable clamps to touch when the cable is connected to the Powerpack.</p>
<p>3 Turn on Vehicle's Engine:</p>  <p>Crank for 4 seconds only.</p>	<p>4 To disconnect Jump-Start Cables:</p>  <p>NO!</p>  <p>Do not allow Jump-start Cable clamps to touch when the cable is connected to the Powerpack.</p>
<p>Jump-Starting a Boat Engine:</p>  <ol style="list-style-type: none"> 1. Ensure the battery to be jump-started is a 12 Vdc. 2. Ensure the Ignition switch is in the OFF position and turn off all accessories. 3. Purge the engine compartment and bilge of all fumes BEFORE jump-starting. 4. Connect and disconnect the same as for an automobile battery. 	

Figure 3-9 Using the Jump-start Cables

Using the Emergency Light

The XPower Powerpack has a built-in incandescent light which will operate for about 30 hours before the unit needs to be recharged.

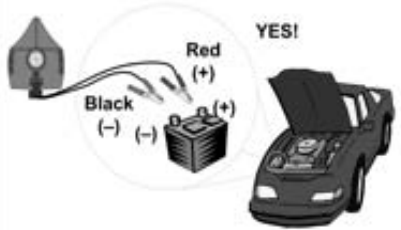
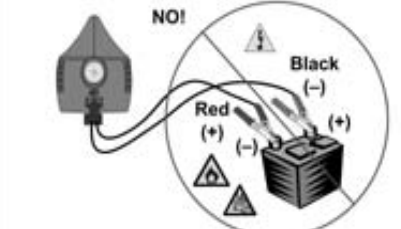
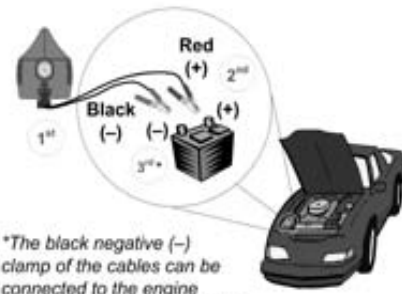
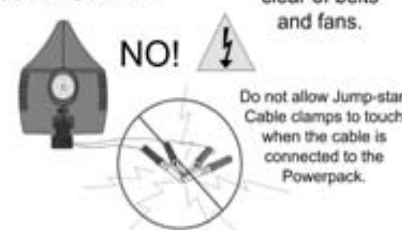
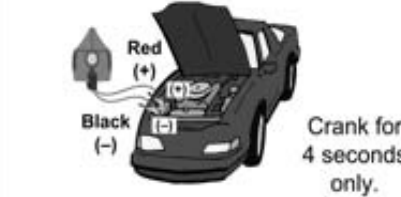
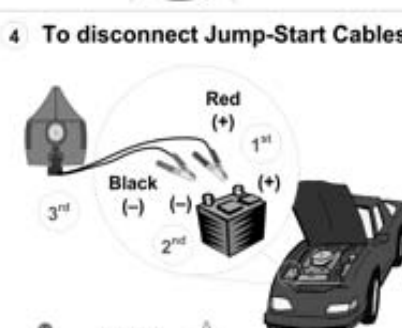
The XPower Powerpack 400 Plus has a two-position OFF/ON switch (located beneath the light's lens).

The XPower Powerpack 400 R has a three-position ON/OFF/Pulse switch. In the "Pulse" position, the light will flash on and off. The XPower Powerpack 400 R also has a red "emergency" light cover that fits over the incandescent light for additional signalling capability.

The direction of the light can be adjusted up and down by pushing against the top or bottom of the rim around the lens.

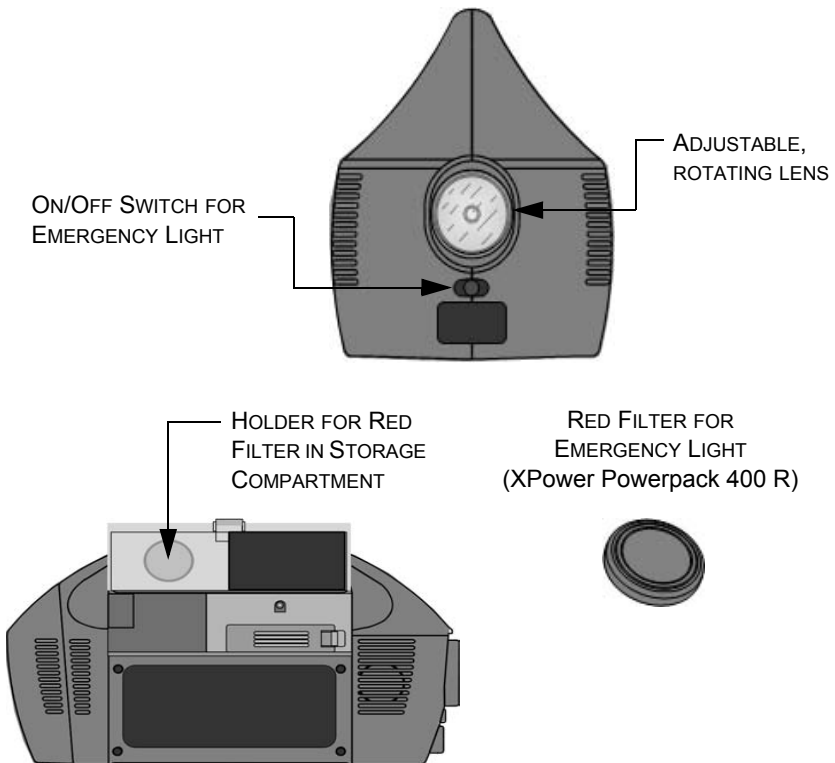
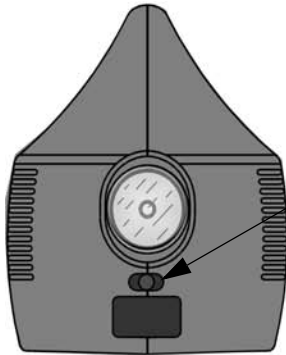

Figure 3-10 Emergency Light

OFF



ON/OFF Switch is in the CENTER position.

ON

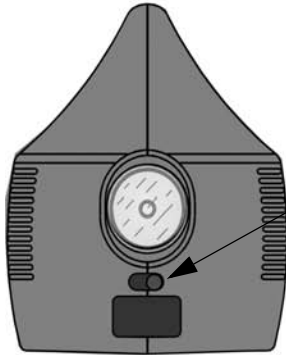

ON/OFF Switch is in the FAR RIGHT position.

PULSE
(XPower Powerpack
400 R only)

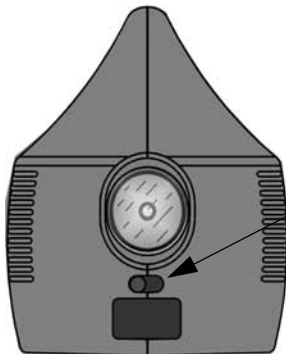

ON/OFF Switch is in the FAR LEFT position.

Figure 3-11 Using the Emergency Light

Using the Air Compressor



WARNING: Fire hazard

The compressor is designed for short term operation only. Operating the compressor over an extended period of time will cause the compressor unit to overheat, which could lead to fire. *Allow the compressor to cool down for 10 minutes after each 10 minutes of continuous operation.*



WARNING: Fire hazard

Do not leave the compressor unattended while in operation. Keep out of reach of children.



WARNING: Risk of personal injury or damage to equipment

Do not exceed the recommended pressure of either the compressor or the object being inflated. The compressor is capable of inflating to 250 PSI. If either recommended pressure is exceeded, an explosion may result.



WARNING: Risk of personal injury or damage to equipment

If the XPower Powerpack shuts off due to an over-temperature condition, turn OFF the power switch and allow the compressor to cool for 15 minutes before re-starting. If the power switch is not turned off before the unit reaches an acceptable operating temperature, the unit will automatically turn itself back on. If left unattended it is possible that the unit can over-inflate the object and create an explosion hazard.



CAUTION

The XPower Powerpack cannot be used to inflate large capacity inflatables such as float tubes, large air mattresses, and inflatable boats. These types of products require extended inflating times which may damage the compressor.

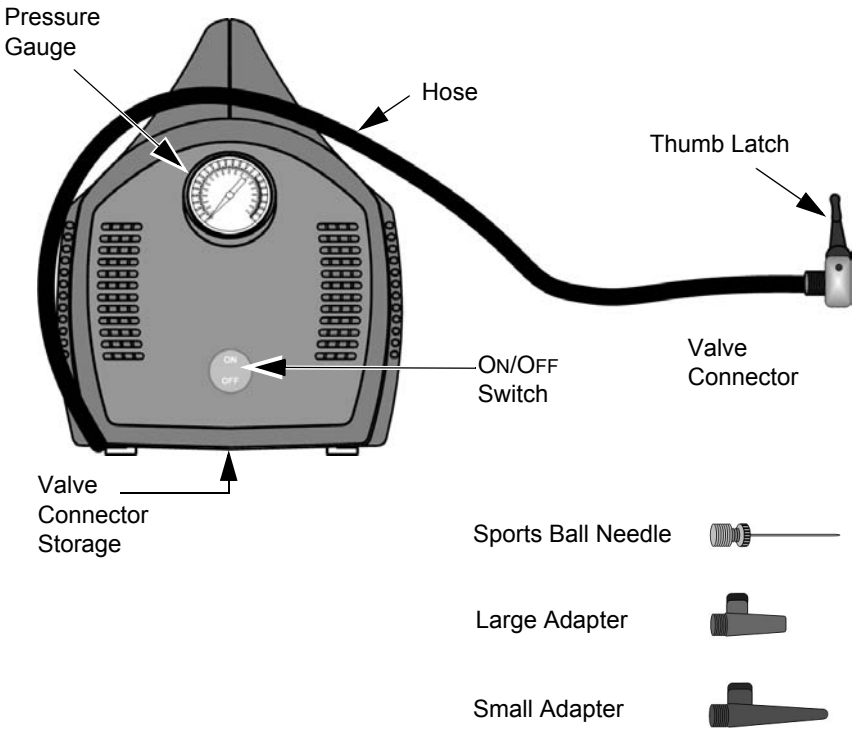
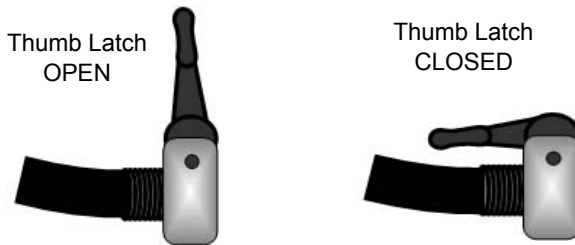
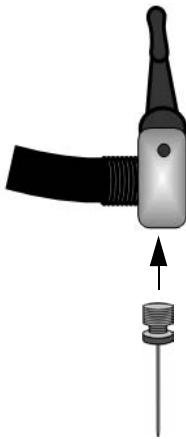

Figure 3-12 XPower Powerpack Air Compressor



Note: Leave the thumb latch in the OPEN position for storing to relieve pressure on the internal mechanisms.

Figure 3-13 Value Connector Usage



Ready to use



To use a Nozzle Adapter:

1. Put the thumb Latch in the OPEN position.
2. Insert the desired adapter into the valve connector.
3. Turn clockwise to tighten.
4. Put the Thumb Latch in the CLOSED position.
5. Insert into the Valve Receptacle on the item to be inflated.
6. Inflate the desired item to the appropriate pressure.
7. Remove the Valve Connector from the valve receptacle.
8. Put the Thumb Latch in the OPEN position.
9. Remove the adapter.
10. Store in either the Accessory Bag or in the small compartment provided inside the storage compartment on the back of the unit.

Figure 3-14 Nozzle Adapter Usage

Over-Temperature Safety Protection

The XPower Powerpack is equipped with an over-temperature safety protection feature that automatically turns the compressor off if it begins to exceed a safe operating temperature.

Once the compressor cools down to its normal operating temperature it will automatically turn on again and continue inflating.

If the XPower Powerpack shuts off due to an over-temperature condition, turn off the power switch and allow the compressor to cool for 15 minutes before re-starting.

Inflating Tires

The information in Table 3-3 is for reference only. For precise pressure specifications, refer to the information supplied with the article to be inflated.

Table 3-3 Pressure Specifications for Common Items

Tires	PSI	Other Inflatables	PSI
520-13	26	Football	13
A-78-14	26	Basketball	9
E78-14	30	Volleyball	5
H-78-14	24	Lawn Tractor Tire	22
HR-78-15	28		
Bicycle Tires			
27-1 ¼	85		
20-1 ½	40		



CAUTION

If the pressure gauge on the compressor indicates more than twice the recommended pressure for the object you are inflating and you have only started to inflate the object, the valve connector is incorrectly connected to the valve stem. This may damage the XPower Powerpack. Remove and reattach the valve connector to the valve stem.

To inflate your vehicle, motorcycle, or bicycle tires:

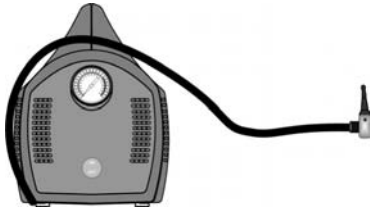

1. Locate Value Connector. Remove from storage and uncoil hose. Install a nozzle adapter if necessary.

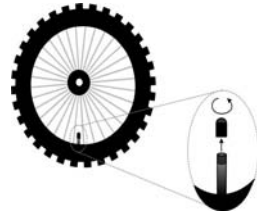

2. Remove Valve Stem Cap from tire to be inflated.

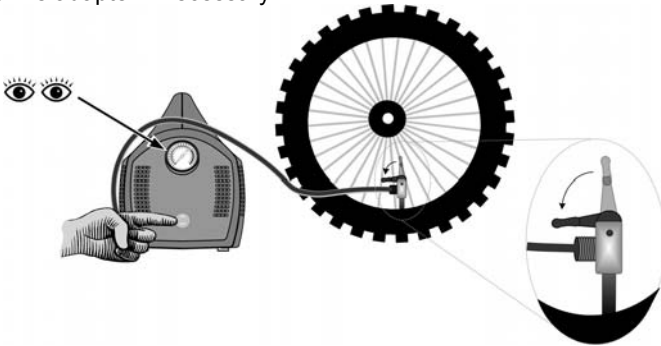

3. Place Valve Connector firmly and completely over valve stem on the tire.
4. Press the Thumb Latch toward the hose until it locks into place.
5. Press the ON/OFF Switch to turn the compressor ON.
6. Inflate to desired pressure.
7. Press the ON/OFF Switch to turn the compressor OFF.

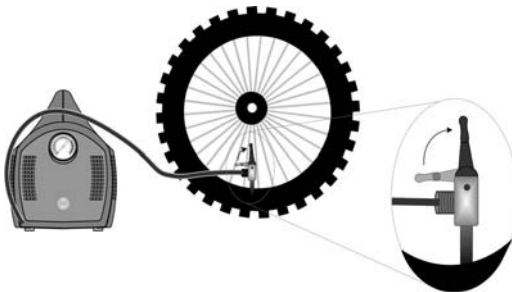

8. Press the Thumb Latch away from the hose and remove from valve stem.

9. Double-check the air pressure with a pressure gauge.



10. Replace Valve Stem Cap

Figure 3-15 Inflating tires

Inflating Small Sports Equipment

You can use the compressor to inflate small sports equipment such as balls (soccer balls and footballs).



CAUTION

The XPower Powerpack cannot be used to inflate large capacity inflatables such as float tubes, large air mattresses, and inflatable boats. These types of products require extended inflating times which may damage the compressor.

To inflate small sports equipment:

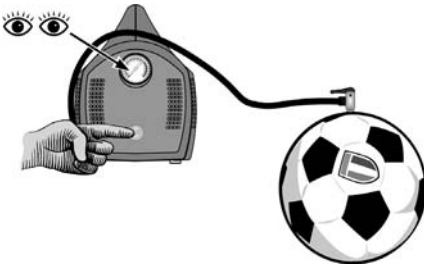

1. Choose the appropriate nozzle adaptor (if required).
2. If an adapter is required, insert the nozzle adaptor into the valve connector, turning it clockwise to tighten, and close the thumb latch.
3. Place the valve connector fully on the valve stem or into the valve receptacle on the item to be inflated.
4. Turn the compressor ON and inflate to appropriate pressure.
5. Turn the compressor OFF before removing valve connector from the valve stem.
6. Remove nozzle adaptor from valve connector and store in storage compartment or Accessory Bag.

Figure 3-16 Inflating Small Sports Equipment



WARNING: Fire hazard

Allow the compressor to cool down for 10 minutes after each 10 minutes of continuous operation. Duplicate.

Note: Leave the thumb latch in the open position for storing to relieve pressure on the internal mechanism.

Using the Radio: XPower Powerpack 400 R

Power Draw

The AM/FM radio on the back panel is powered by the internal battery in the XPower Powerpack 400 R.

When turned on, the radio draws 30 mA, allowing you to use the radio for more than one month when the XPower Powerpack 400 R is fully charged.

Listening to the AM Band

Due to signal interference, you cannot listen to the AM band while using the XPower Powerpack 400 R to operate an AC appliance.

Radio Features

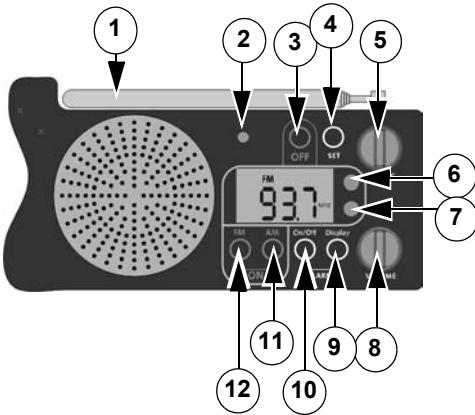

Feature	Description
①	FM antenna
②	Frequency indicator light
③	Power OFF button
④	Time set button
⑤	Tuning dial
⑥	Hours set button
⑦	Minutes set button
⑧	Volume dial
⑨	Alarm set button
⑩	Alarm clock ON/OFF button
⑪	AM band button/ON
⑫	FM band button/ON

Figure 3-17 Radio Features

Radio Operation

How to...	Required Condition	Required Action	Note
Listen to the radio		Press the AM band button (11) or the FM band button (12). To turn off the radio, press the power OFF button (3).	When radio is on, the station frequency is displayed. When radio is off, the time is displayed.
Set the clock	Turn off the radio to show the time.	To adjust hour, press and hold Time Set button (4), and press hours set button (6). To adjust minutes, press and hold (4), and press minutes set button (7).	The clock uses a 12-hour (AM/PM) time format.
Set the alarm	Turn off the radio to show the time.	To adjust hour, press and hold Alarm Set button (9), and press hours set button (6). To adjust minutes, press and hold (9), and press minutes set button (7).	The alarm clock uses a 12-hour (AM/PM) time format.
Use the alarm clock	Set the alarm, turn off radio to show time.	Press Alarm Clock ON/OFF button (10). "A" shows on the display screen.	When the alarm clock turns the radio on, the power off button (3) does not work. To turn off the radio, press Alarm Clock ON/OFF (10), then press (3).
Improve reception	Radio tuned to FM station.	Adjust the direction and length of the FM antenna.	N/A.

Connecting to an External Battery

You can extend battery operating times by connecting the XPower Powerpack to a larger external 12 Vdc battery.

For example, an external 60 Ah battery gives approximately four times the operating time of the XPower Powerpack internal 20 Ah battery.



WARNING: Acid spills

Use a sealed, non-spillable battery for indoor use. Common auto and marine batteries are not suitable for indoor use unless their fumes are vented outdoors. Common auto and marine batteries contain acid, which is hazardous if spilled. Wear eye protection and protective clothing when connecting the XPower Powerpack to an external battery.



WARNING: Fire hazard

Never allow jump-start cables' red and black clamps to touch each other or another common metal conductor. This could cause damage to the unit and/or create a sparking/explosion hazard. Always disconnect the jump-start cables from the unit after use and clip the plastic guard over the jump-start cable port.



WARNING: Fire hazard

Jump-start cable clamps must be connected positive to positive (red clamp to battery "+") and negative to negative (black clamp to battery "-"). A reverse polarity connection (positive to negative) may cause damage to the unit and/or create a sparking/explosion hazard.



WARNING: Sparking and explosion

Do not remove the cables from the Jump-Start Cable Port when the positive and negative clamps are connected to the terminals of the external battery.



CAUTION

Do not recharge the XPower Powerpack when an external battery is connected. The AC charger may be damaged.

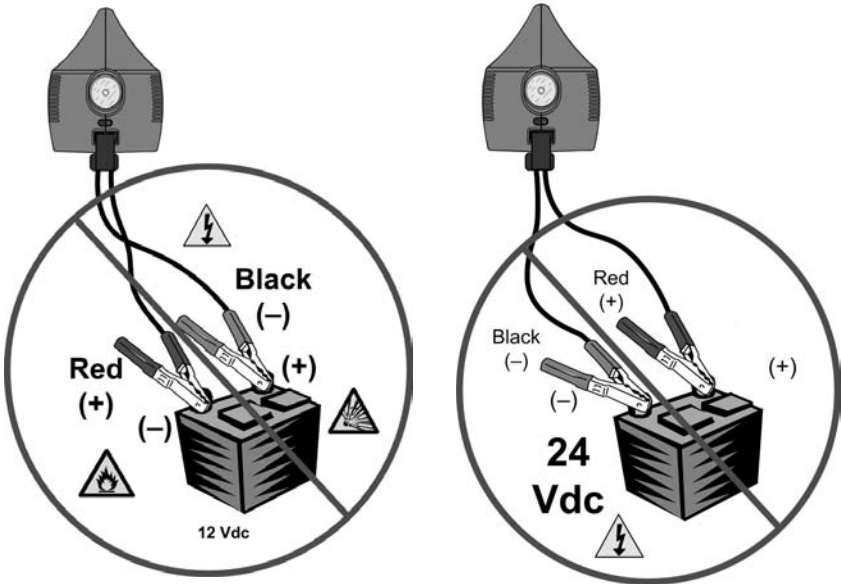

Do NOT reverse the polarity of the battery!

Only connect to a 12 Vdc Battery.

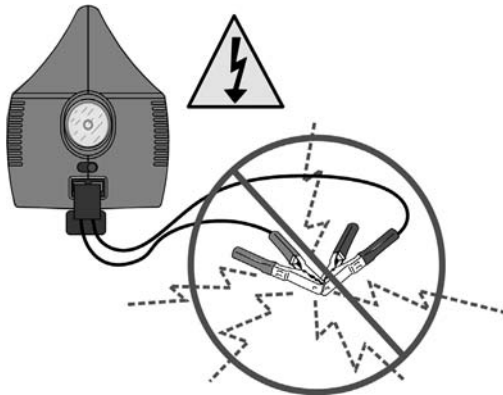

Do NOT allow the clamps on the Jump-start cable touch each other when connected to the XPower Powerpack.!

Figure 3-18 Basic Jump-start Cable Safety

To connect the XPower Powerpack to an external battery using the jump-start cables:

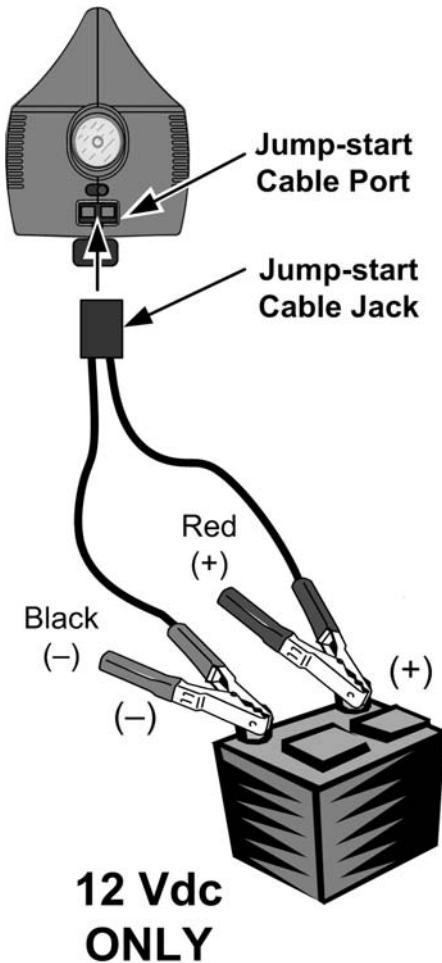

To connect the XPower Powerpack to an external battery using the jump-start cables:

1. Connect the cables to the Jump-Start Cable Port on the left side of the XPower Powerpack.
2. Connect the black negative (-) clamp of the cables to the black negative (-) terminal of the external battery.
3. Connect the red positive (+) clamp of the cables to the red positive (+) terminal of the external battery.

To disconnect the cables from an external battery and from the XPower Powerpack:

1. Remove the red positive (+) clamp second.
2. Remove the black negative (-) clamp first.
3. Remove the cables from the Jump-Start Cable Port last.
4. Replace the plastic port cover over the Jump-start cable port.

Figure 3-19 Connecting the XPower Powerpack to an External Battery

4 Maintenance

Chapter 4 provides information on maintaining your internal battery, recharging options for the internal battery, and replacing user-replaceable parts.

Routine maintenance is required to keep your XPower Powerpack operating properly. Occasionally clean the exterior of the unit with a damp cloth to remove the accumulated dust and dirt.



WARNING: Shock hazard

Disconnect all sources of AC power and DC power before performing any type of maintenance.

Battery Maintenance

All rechargeable batteries gradually discharge when left standing and need to be recharged periodically to maintain maximum battery capacity. The AC Charger supplied with the XPower Powerpack is designed to regulate the charging process, ensuring that the battery is always fully charged but never overcharged. To ensure safe recharging and maximum battery life, recharge the XPower Powerpack only with the supplied chargers or approved battery chargers.



CAUTION

Due to inherent self-discharge, lead acid batteries must be charged at least every 3 months, especially in a warm environment. Leaving a battery in a discharged state, or not recharging every 3 months, may result in permanent battery damage and poor jump-start performance. ***Damage to the battery caused by neglect is not covered by the product warranty.***

Replacing the Internal Battery



WARNING: Shock or electrical hazard

Read this entire section before disassembling the unit.



WARNING

If you do not know how to safely remove and install batteries, have this task performed by a qualified service technician.



WARNING: Fire hazard

When installing the replacement battery, make sure the battery polarity is correct. Reverse polarity will damage the XPower Powerpack and could cause serious injury.

Battery Life

The high quality battery used in the XPower Powerpack will serve as a reliable power source for years when properly maintained. To maximize battery life, it is important to recharge the XPower Powerpack battery after each use.

To maximize battery life, it is important to recharge the XPower Powerpack battery after each use.

Important: Recharge the XPower Powerpack fully at least every three months if it is placed in storage or in a vehicle trunk. Store in a location that maintains a temperature range between 32 and 86 °F (0 and 30 °C).



CAUTION

Discharging the internal battery below 10.0 V will damage the battery and shorten its life.

Obtaining a Replacement Battery

When the battery reaches the end of its service life, you may purchase a replacement through an industrial battery supplier. The supplier should specialize in deep-cycle batteries. The recommended replacement batteries are standard sizes used for a variety of applications (not just the Powerpack), so you may rest assured that the battery will continue to be widely available many years into the future.

The factory-installed 20 amp-hour battery in your Powerpack is not available in North America. The recommended replacement batteries have smaller amp-hour capacities. Using smaller capacity batteries will not affect the Powerpack's output power, but will result in slightly shorter runtimes for AC and DC products.

Refer to [the table below] for a list of batteries approved for use with the XPower Powerpack:

Table 4-1 Battery Replacement

Battery	Capacity (Ah)
SLA1122 (ibsa.com)	18
SLA-12V18 (batterymart.com)	18
SLA-12170 (gotbatteries.com)	17
UB12180 (batterywholesale.com)	18
Yuasa NP18-12BFR (gotbatteries.com)	18
EP17-12-B1 (powerstream.com)	17
Power-Sonic PSH-12180 (batteryweb.com)	18
Panasonic LC-X1220P (gotbatteries.com)	18

For the latest battery replacement information, visit www.xantrex.com/support and view the Powerpacks FAQ. The Powerpacks FAQ has a battery replacement guide.

Battery Replacement Procedure

Before attempting to replace the internal battery, make sure you:

- Disconnect any charging cables, 12 volt DC appliances, and AC appliances from the XPower Powerpack.
- Turn off the AC Outlet ON/OFF switch and turn off the light switch.
- Remove the jump-start cables.

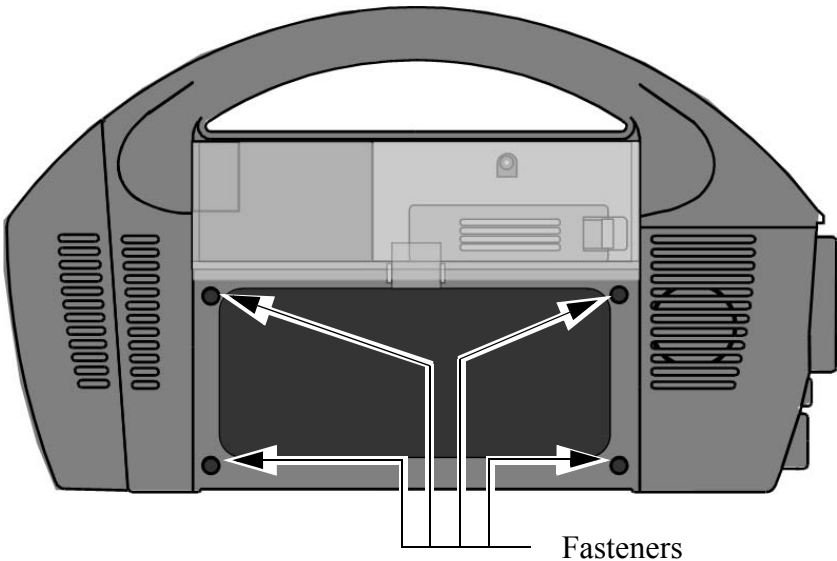

Figure 4-1 Accessing the Internal Battery for Replacement

To replace the battery:

1. Place the XPower Powerpack upright on a stable, level surface.
2. On the backside of the XPower Powerpack, unscrew the four fasteners on the battery cover. Place the fasteners in the cover for safe keeping.
3. Disconnect the wires on the battery only.

4. After removing the old battery, position the new battery close to the back of the XPower Powerpack.
Make sure the positive battery terminal is next to the red positive (+) internal cable and the black negative terminal is next to the black negative (-) internal cable.
5. Securely fasten the bolt and washer that holds the red positive (+) cable to the positive (+) battery terminal and the black negative (-) cable to the negative (-) battery terminal.
6. Do not overtighten the bolt. Consult the battery manufacturer for torque specifications.
7. On the XPower Powerpack, replace the battery cover and the four fasteners.
8. Dispose of the old battery in an environmentally responsible manner.

Replacing the Incandescent Light

To replace a light bulb:

1. Turn the light switch off.
2. Unscrew the cover and lens.
3. Gently grasp the bulb and pull to remove the light reflector assembly and the bulb.
4. While holding the light reflector assembly, gently unscrew the black knob at the back of the assembly.
5. Remove the old bulb and insert a replacement bulb of the same type and rating into the light reflector assembly.
Replacement Lamp: Part # 030-9951-01 5 watt 12-v lamp.
6. Holding the light reflector assembly, gently screw the black knob on to the back of the assembly.
7. Reattach the lens and cover.

Replacing the External Fuse

The replacement fuse must be rated at 250 A, 32 Vdc.
(MEGA Fuse - 2 11/16" x 3/4" Holes: 2" on center. Max.
32-volt DC)

To replace the external fuse:

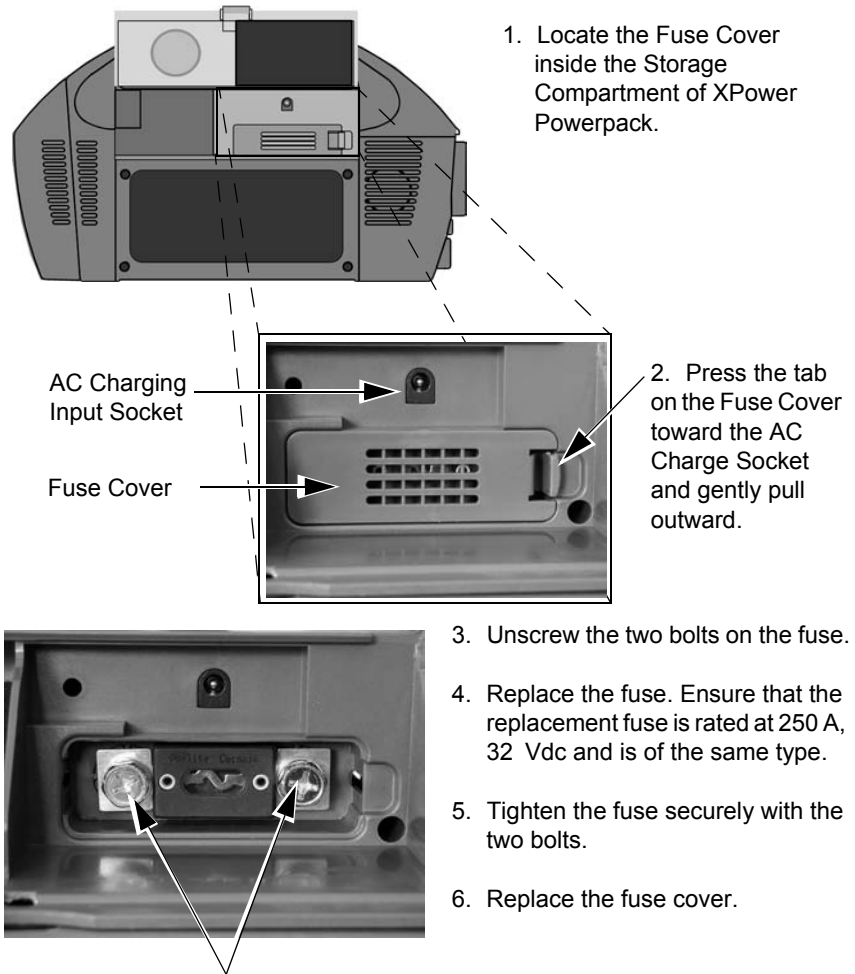

Figure 4-2 Replacing the Fuse

Recycling

The XPower Powerpack is designed to provide years of service. However, when the internal battery reaches the end of its service life, you will need to replace it as described in your manual.

Because the internal battery contains lead, which can be hazardous if exposed to the environment, the old internal battery should be recycled or safely disposed of at your local recycling depot.

Do not dispose of the old internal battery with common household waste. Please ask your local authorities about recycling services that are available in your area.

The following website provides additional recycling information:

<http://www.earth911.org/master.asp>

A Specifications

Chapter A, “Specifications” includes the electrical, mechanical, and environmental specifications for the XPower Powerpack.

Electrical Specifications

12 V DC Section	
Internal battery type	sealed, AGM (Absorbed Glass Mat) lead acid
Internal battery voltage (nominal)	12 Vdc
Internal battery capacity (minimum)	20 Ah
Internal battery CCA rating	200 CCA
DC Power Socket (maximum continuous load)	12 A with automatic reset
Built-in incandescent light (replaceable)	5 W bulb
Jump-start cable port	50 A
Jump-start fuse (external—user replaceable, replacement part # 066-0191)	250 A

Specifications

AC Power Section	
Output power <ul style="list-style-type: none">• Continuous output power• Five minute AC output power• AC output surge capacity	320 W 400 W 600 W
Output voltage	115 ± 10 Vac RMS
Output frequency	60 Hz ± 4 Hz
Output wave form	modified sine wave
No load current draw	<0.20 Adc
Input voltage range	10.5 to 15.0 Vdc
Low battery alarm	11.0 Vdc
Low battery shutdown	10.5 V dc
High battery voltage shutdown	Yes, automatic reset
Over temperature shutdown	Yes, automatic reset
Overload shutdown	Yes, automatic reset
AC output short circuit protection	Yes, automatic reset
Fuse (internal)	2 x 25 A or 1 x 50 A
Operating temperature range	32 – 104 °F (0 – 40 °C)
Storage temperature range	32 – 86°F (0 – 30 °C)

Internal Battery Charging Controller System	
AC Charger bulk charging current	750 mA
Peak charging voltage (nominal)	14.2 V
Charge restart voltage (nominal)	12.9 V
Float charge after full charge is completed (nominal)	1 mA
AC Charger input socket maximum current	2.5 A

Air Compressor	
Pressure	250 PSI (lb./in ²)

Radio (XPower Powerpack 400 R only)	
AM Frequency	526–1606 KHz
FM Frequency	87-109 MHz

Accessories	
Jump-start cables (replacement part # 449-0207-01-01)	24" (0.61 m), 4 AWG wire with black and red battery clamps
DC-to-DC charge cable (replacement part # 449-0187-01-01)	39" (1 m) 18 AWG with male to male lighter plugs
AC Charger input cable (replacement part # 074-1004)	120 ± 10 Vac, 60 Hz
Nozzle adaptor (for air compressor, (replacement part # 160-0015-01-01)	two nozzle adaptors (large and small)
	one sports needle adaptor
Incandescent Light Bulb	Replacement Lamp: Part # 030-9951-01 5 watt 12-v lamp.

Physical Specifications

Physical specifications	XPower Powerpack 400 Plus	XPower Powerpack 400 R
Depth	8" (20.3 cm)	8" (20.3 cm)
Width	16" (40.8 cm)	16" (40.8 cm)
Height	9 ½" (24.1 cm)	9 ½" (24.1 cm)
Weight	21.8 lb. (9.9 kg)	23 lb. (10.5 kg)

Important: All specifications are subject to change without notice.

5

Troubleshooting

Troubleshooting will help you identify the common problems than can occur with the XPower Powerpack.

Read this chapter before calling Customer Service.

If you cannot solve the problem with the XPower Powerpack, record the information asked for on “Information About Your System” on page WA-5 and then contact your dealer.

Common Problems

Buzz in Audio Equipment

Some inexpensive stereo systems have inadequate internal power-supply filtering and may buzz slightly when powered by the XPower Powerpack. The best solution to eliminate the buzzing is to use an audio system with a good quality filter.

Television Interference

The XPower Powerpack is shielded to minimize interference with TV signals. If TV signals are weak, you may see interference in the form of lines scrolling across the TV screen. Try one of the following suggestions to minimize or eliminate the interference:

- Use an extension cord to increase the distance between the XPower Powerpack and the TV, antenna, and cables.
- Adjust the orientation of the XPower Powerpack, television, antenna, and cables.
- Maximize TV signal strength by using a better antenna. Use a shielded antenna cable where possible.
- Try a different TV. Different models vary considerably in their susceptibility to interference.

Troubleshooting Reference



WARNING: Electric shock hazard

Do not remove the cover of the XPower Powerpack or disassemble the XPower Powerpack except to replace the internal battery or 250 A fuse. The XPower Powerpack does not contain any internal user-serviceable parts and attempting to service the unit yourself could result in electrical shock or burn.

Table 5-1 Troubleshooting reference

Problem	Possible Cause	Solution
AC appliance will not operate; audible alarm is not sounding.	AC appliance rated more than 320 W, the safety overload has tripped.	Use an AC appliance with a power rating less than 320 W.
	AC appliance is rated less than 320 W, high starting surge has tripped the safety overload.	AC appliance may exceed the XPower Powerpack’s surge capability. Use an AC appliance with a starting surge within the XPower Powerpack surge rating.
Overload shutdown	Appliance power requirements exceed the capability of the XPower Powerpack.	Unplug the appliance and confirm that the appliance’s power requirement is 320 Wac/144Wdc or less before attempting to restart the appliance.
AC appliance will not operate; audible alarm is sounding.	Battery has discharged to 10.5 V.	Turn the AC Outlet ON/OFF switch off and recharge the XPower Powerpack.
	Inverter has overheated due to poor ventilation or excessively warm environmental conditions.	Turn the AC Outlet ON/OFF switch off and allow the XPower Powerpack to cool for 15 minutes or more. Clear blocked fan opening or remove objects covering the unit, then restart the XPower Powerpack. Move to a cooler environment.

Table 5-1 Troubleshooting reference

Problem	Possible Cause	Solution
Over-temperature shutdown	Inverter has overheated due to poor ventilation or excessively warm environmental conditions.	<p>Turn off the AC Outlet ON/OFF switch and let the XPower Powerpack cool down.</p> <p>Disconnect the 12Vdc appliance and let the XPower Powerpack cool down.</p>
Alarm sounds	<p>Internal battery is nearly discharged. (11.0 V). If you ignore this warning, the XPower Powerpack automatically switches off when the battery reaches 10.5 V.</p>	<p>Turn the AC outlet ON/OFF switch OFF and recharge the XPower Powerpack.</p>
Measured AC output voltage is too low.	<p>Use of an average-reading AC voltmeter to read output voltage.</p> <p>Battery is almost fully discharged.</p>	<p>The modified sine wave (MSW) output of the XPower Powerpack requires a true RMS reading meter, such as the Fluke 87 series, for accurate measurement. A typical reading on a non-true RMS meter should show between 98 Vac to 120 Vac.</p> <p>Press Display Function button to verify battery status and recharge the XPower Powerpack as necessary.</p> <p>“Battery Charge %” reading on the digital display is only accurate when the XPower Powerpack has been disconnected from all appliances and all charging sources for fifteen minutes.</p>

Table 5-1 Troubleshooting reference

Problem	Possible Cause	Solution
Run time is less than expected.	<p>Internal battery is not fully charged.</p> <p>AC appliance power consumption is higher than expected.</p>	<p>Recharge using the AC Charger, until green Charging Status light is steady.</p> <p>Check AC appliance power or wattage rating (or current draw for 12 V dc appliances) and compare with Table 3-1 on page 3–11 and Table 3-2 on page 3–14. For additional information on battery run times, see the Battery App Note under the Support Section at www.xantrex.com.</p>
Charging Status light is OFF when AC Charger is connected	<p>No AC power at the AC wall outlet.</p> <p>AC Charger is faulty.</p>	<p>Ensure power is available at the AC wall outlet.</p> <p>Replace the AC Charger.</p>
Green Charging Status light is flashing (indicating recharging) and Battery Charge (%) does not turn on.	Battery Charge (%) reading on digital display is only accurate when the XPower Powerpack has been disconnected from all appliances and all charging sources for fifteen minutes.	Unplug the charging sources and any appliances and let the XPower Powerpack rest for 15 minutes to obtain an accurate reading.
The compressor runs slowly.	<p>The compressor may have overheated from excessive use.</p> <p>Battery voltage is too low.</p>	<p>Turn off the compressor and let it cool down.</p> <p>Check the condition of the internal battery. The battery may need to be recharged or replaced.</p>

Table 5-1 Troubleshooting reference

Problem	Possible Cause	Solution
<p>Green Charging Status light is still flashing and hasn't changed to steady after 50 hours of charging.</p>	<p>The voltage at the AC wall outlet is less than 120 Vac.</p> <p>Internal battery is permanently damaged.</p>	<p>Use AC wall outlet that supplies 120 Vac.</p> <p>Replace the battery.</p>
<p>The compressor runs but won't inflate.</p>	<p>The valve connector may not be securely placed on the valve stem.</p> <p>The item being inflated may have a leak.</p>	<p>Check that the valve connector is securely placed on the valve stem before closing the thumb latch.</p> <p>Check that the item being inflated has no leaks.</p> <p>Check the compressor hose for any breaks or leaks at connections.</p>
<p>The engine being jump-started will not start.</p>	<p>XPower Powerpack battery is not fully charged.</p> <p>The engine condition is poor.</p> <p>External fuse (250 A) is blown.</p> <p>The engine start capacity exceeds the XPower Powerpack jump-start capability.</p>	<p>Recharge the XPower Powerpack battery.</p> <p>Have the engine serviced.</p> <p>Replace 250 A, 32 V fuse with same type and ratings.</p>

Table 5-1 Troubleshooting reference

Problem	Possible Cause	Solution
The battery clamps of the jump-start cables measure zero volts.	External fuse (250 A) is blown.	Replace 250 A, 32 V fuse with same type and ratings. See “Replacing the External Fuse” on page 4–6.
The light does not turn on.	Light bulb has burnt out.	Remove lens cover and replace bulb with one of the same type and rating. See “Replacing the Incandescent Light” on page 4–5.
The AM radio does not work or buzzes continuously (XPower Powerpack 400 R only).	The XPower Powerpack AC outlets are being used, causing interference.	Turn off the AC outlets.

Warranty and Return

Warranty

What does this warranty cover? This Limited Warranty is provided by Xantrex Technology Inc. ("Xantrex") and covers defects in workmanship and materials in your XPower Powerpack 400 Plus and XPower Powerpack 400 R. This warranty period lasts for 6 months from the date of purchase at the point of sale to you, the original end user customer. You require proof of purchase to make warranty claims.

What will Xantrex do? Xantrex will, at its option, repair or replace the defective product free of charge, provided that you notify Xantrex of the product defect within the Warranty Period, and provided that Xantrex through inspection establishes the existence of such a defect and that it is covered by this Limited Warranty.

Xantrex will, at its option, use new and/or reconditioned parts in performing warranty repair and building replacement products. Xantrex reserves the right to use parts or products of original or improved design in the repair or replacement. If Xantrex repairs or replaces a product, its warranty continues for the remaining portion of the original Warranty Period or 90 days from the date of the return shipment to the customer, whichever is greater. All replaced products and all parts removed from repaired products become the property of Xantrex.

Xantrex covers both parts and labor necessary to repair the product, and return shipment to the customer via a Xantrex-selected non-expedited surface freight within the contiguous United States and Canada. Alaska and Hawaii are excluded. Contact Xantrex Customer Service for details on freight policy for return shipments outside of the contiguous United States and Canada.

How do you get service? If your product requires troubleshooting or warranty service, contact your dealer.

If you are unable to contact your dealer, or the dealer is unable to provide service, contact Xantrex directly at:

Phone: 1 360-925-5059

Fax: 1 360-925-5143

Website: www.xantrex.com/support

Direct returns may be performed according to the Xantrex Return Material Authorization Policy described in your product manual. For some products, Xantrex maintains a network of regional Authorized Service Centers. Call Xantrex or check our website to see if your product can be repaired at one of these facilities.

What proof of purchase is required? In any warranty claim, dated proof of purchase must accompany the product and the product must not have been disassembled or modified without prior written authorization by Xantrex.

Proof of purchase may be in any one of the following forms:

- The dated purchase receipt from the original purchase of the product at point of sale to the end user, or
- The dated dealer invoice or purchase receipt showing original equipment manufacturer (OEM) status, or
- The dated invoice or purchase receipt showing the product exchanged under warranty

Warranty and Return

What does this warranty not cover? This Limited Warranty does not cover normal wear and tear of the product or costs related to the removal, installation, or troubleshooting of the customer's electrical systems. This warranty does not apply to and Xantrex will not be responsible for any defect in or damage to:

- a) the product if it has been misused, neglected, improperly installed, physically damaged or altered, either internally or externally, or damaged from improper use or use in an unsuitable environment;
- b) the product if it has been subjected to fire, water, generalized corrosion, biological infestations, or input voltage that creates operating conditions beyond the maximum or minimum limits listed in the Xantrex product specifications including high input voltage from generators and lightning strikes;
- c) the product if repairs have been done to it other than by Xantrex or its authorized service centers (hereafter "ASCs");
- d) the product if it is used as a component part of a product expressly warranted by another manufacturer;
- e) the product if its original identification (trade-mark, serial number) markings have been defaced, altered, or removed.

Disclaimer

Product

THIS LIMITED WARRANTY IS THE SOLE AND EXCLUSIVE WARRANTY PROVIDED BY XANTREX IN CONNECTION WITH YOUR XANTREX PRODUCT AND IS, WHERE PERMITTED BY LAW, IN LIEU OF ALL OTHER WARRANTIES, CONDITIONS, GUARANTEES, REPRESENTATIONS, OBLIGATIONS AND LIABILITIES, EXPRESS OR IMPLIED, STATUTORY OR OTHERWISE IN CONNECTION WITH THE PRODUCT, HOWEVER ARISING (WHETHER BY CONTRACT, TORT, NEGLIGENCE, PRINCIPLES OF MANUFACTURER'S LIABILITY, OPERATION OF LAW, CONDUCT, STATEMENT OR OTHERWISE), INCLUDING WITHOUT RESTRICTION ANY IMPLIED WARRANTY OR CONDITION OF QUALITY, MERCHANTABILITY OR FITNESS FOR A PARTICULAR PURPOSE. ANY IMPLIED WARRANTY OF MERCHANTABILITY OR FITNESS FOR A PARTICULAR PURPOSE TO THE EXTENT REQUIRED UNDER APPLICABLE LAW TO APPLY TO THE PRODUCT SHALL BE LIMITED IN DURATION TO THE PERIOD STIPULATED UNDER THIS LIMITED WARRANTY.

IN NO EVENT WILL XANTREX BE LIABLE FOR ANY SPECIAL, INDIRECT, INCIDENTAL OR CONSEQUENTIAL DAMAGES, LOSSES, COSTS OR EXPENSES HOWEVER ARISING WHETHER IN CONTRACT OR TORT INCLUDING WITHOUT RESTRICTION ANY ECONOMIC LOSSES OF ANY KIND, ANY LOSS OR DAMAGE TO PROPERTY, ANY PERSONAL INJURY, ANY DAMAGE OR INJURY ARISING FROM OR AS A RESULT OF MISUSE OR ABUSE, OR THE INCORRECT INSTALLATION, INTEGRATION OR OPERATION OF THE PRODUCT.

Exclusions

If this product is a consumer product, federal law does not allow an exclusion of implied warranties. To the extent you are entitled to implied warranties under federal law, to the extent permitted by applicable law they are limited to the duration of this Limited Warranty. Some states and provinces do not allow limitations or exclusions on implied warranties or on the duration of an implied warranty or on the limitation or exclusion of incidental or consequential damages, so the above limitation(s) or exclusion(s) may not apply to you. This Limited Warranty gives you specific legal rights. You may have other rights which may vary from state to state or province to province.

Warning: Limitations On Use

Please refer to your product manual for limitations on uses of the product.

SPECIFICALLY, PLEASE NOTE THAT THE XPOWER POWERPACK 400 PLUS AND XPOWER POWERPACK 400 R SHOULD NOT BE USED IN CONNECTION WITH LIFE SUPPORT SYSTEMS OR OTHER MEDICAL EQUIPMENT OR DEVICES. WITHOUT LIMITING THE GENERALITY OF THE FOREGOING, XANTREX MAKES NO REPRESENTATIONS OR WARRANTIES REGARDING THE USE OF THE XANTREX XPOWER POWERPACK 400 PLUS AND XPOWER POWERPACK 400 R IN CONNECTION WITH LIFE SUPPORT SYSTEMS OR OTHER MEDICAL EQUIPMENT OR DEVICES.

Please note that the XPower Powerpack 400 Plus and XPower Powerpack 400 R is not intended for use as an uninterruptible power supply and Xantrex makes no warranty or representation in connection with any use of the product for such purposes.

Return Material Authorization Policy

Before returning a product directly to Xantrex you must obtain a Return Material Authorization (RMA) number and the correct factory "Ship To" address. Products must also be shipped prepaid. Product shipments will be refused and returned at your expense if they are unauthorized, returned without an RMA number clearly marked on the outside of the shipping box, if they are shipped collect, or if they are shipped to the wrong location.

When you contact Xantrex to obtain service, please have your instruction manual ready for reference and be prepared to supply:

- The serial number of your product
- Information about the installation and use of the unit
- Information about the failure and/or reason for the return
- A copy of your dated proof of purchase

Record these details in "Information About Your System" on page WA-5.

Return Procedure

1. Package the unit safely, preferably using the original box and packing materials. Please ensure that your product is shipped fully insured in the original packaging or equivalent. This warranty will not apply where the product is damaged due to improper packaging.
2. Include the following:
 - The RMA number supplied by Xantrex Technology Inc. clearly marked on the outside of the box.
 - A return address where the unit can be shipped. Post office boxes are not acceptable.
 - A contact telephone number where you can be reached during work hours.
 - A brief description of the problem.
3. Ship the unit prepaid to the address provided by your Xantrex customer service representative.

If you are returning a product from outside of the USA or Canada In addition to the above, you **MUST** include return freight funds and are fully responsible for all documents, duties, tariffs, and deposits.

If you are returning a product to a Xantrex Authorized Service Center (ASC) A Xantrex return material authorization (RMA) number is not required. However, you must contact the ASC prior to returning the product or presenting the unit to verify any return procedures that may apply to that particular facility.

Out of Warranty Service

If the warranty period for your XPower Powerpack 400 Plus and XPower Powerpack 400 R has expired, if the unit was damaged by misuse or incorrect installation, if other conditions of the warranty have not been met, or if no dated proof of purchase is available, your unit may be serviced or replaced for a flat fee.

To return your XPower Powerpack 400 Plus and XPower Powerpack 400 R for out of warranty service, contact Xantrex Customer Service for a Return Material Authorization (RMA) number and follow the other steps outlined in “Return Procedure” on page WA-4.

Payment options such as credit card or money order will be explained by the Customer Service Representative. In cases where the minimum flat fee does not apply, as with incomplete units or units with excessive damage, an additional fee will be charged. If applicable, you will be contacted by Customer Service once your unit has been received.

Information About Your System

As soon as you open your XPower Powerpack 400 Plus and XPower Powerpack 400 R package, record the following information and be sure to keep your proof of purchase.

- Serial Number _____
- Purchased From _____
- Purchase Date _____

If you need to contact Customer Service, please record the following details before calling. This information will help our representatives give you better service.

- Warning, Error or Panel Fault Message _____
 - Appliances operating when problem occurred _____
 - Description of problem _____
- _____
- _____

